



SPECIAL DISTRICTS APPLICATION

Change of use from office to traveler's accommodation, lodging, for the first 9 floors, including portions of the lobby space, and 450 sf of outdoor dining area on ground floor.

Application Stage: Pre-application [] Application [x]

Permit Activity Number: T21SA00230 DP20-0164

Case Number: DRB-21-13

Date Accepted: 6/24/2021

PROPERTY LOCATION AND PROPOSED DEVELOPMENT

Project / Development Name (if applicable): One South Church Hotel

Property Address: 1 South Church Ave

Pima County Tax Parcel Number/s: 117-12-103C

Current Zoning: OCR-2

Applicable Overlay/ Special Districts: [x] Infill Incentive District [x] Rio Nuevo Area [] Main Gate Overlay District [] Grant Road Overlay District [] Neighborhood Preservation Zone [] Historic Preservation Zone

Neighborhood Association (if any):

PROJECT TYPE (check all that apply): Change of use to existing building [x] New building on vacant land [] New building on developed land [] New addition to existing building [] Other

Description of Proposed Use: Travelers Accommodation / Lodging, Office

Number of Buildings and Stories/Height of Proposed Structure(s): Existing 25 story, 323' tall building

Site Area (sq ft): 31,726 sf Area of Proposed Building (sq ft): 285,521 sf

HISTORIC STATUS

Site is within a: Historic Preservation Zone Please List: National Register District Please List: Site is/includes: [] A contributing structure [] Non-contributing structure [] Is adjacent to a contributing structure [] Vacant

APPLICANT INFORMATION (The person processing the application and designated to receive notices):

APPLICANT NAME: Adam Kogan, AIA

ROLE: [] Property owner [x] Architect [] Engineer [] Attorney [] Developer Other: _____

EMAIL: akogan@nelsenpartners.com PHONE: 480.621.4846

ADDRESS: 15210 N. Scottsdale Road, Ste. 300, Scottsdale, AZ 85254

PROPERTY OWNER NAME(S) (If ownership in escrow, please note): 1sc Hotel QOZB LLC (Contact: Tyler Kent)

PHONE: 480.470.9200

I hereby certify that all information contained in this application is complete and true to the best of my knowledge.

SIGNATURE OF OWNER/APPLICANT*

*If an authorized representative is signing on behalf of the property owner, please provide a letter of authorization Date 6/18/2021

Adam Kogan

From: Tyler Kent <tk@opwestpartners.com>
Sent: Friday, June 18, 2021 10:40 AM
To: Adam Kogan
Cc: George Melara
Subject: Nelsen

Adam –

We authorize Nelsen to submit our Special Districts Application for the One South Church hotel. Owner is 1sc Hotel QOZB LLC . Other contact information is below.

Tyler A. Kent

Managing Director

Opwest Partners

6900 E. Camelback Rd., Suite 902
Scottsdale, AZ 85251

(w) 480-470-9200

(m) 602-672-9380

tk@opwestpartners.com

www.opwestpartners.com

OPWEST | PARTNERS

Revised 6.14.2021 as requested by DTM

One South Church Hotel

Church Avenue Operations Overview

Overview

The purpose of this document is to provide a framework for the 1 S. Church hotel (“Hotel”) operational functions that will take place along Church Avenue. In discussions with the City of Tucson (“City”) Department of Transportation and Mobility (“DTM”), peak hours in the downtown area are 6-9 a.m. and 5:30-7 p.m. weekdays (“Peak Hours”). The goal is to avoid traffic conflicts as much as possible during these Peak Hours.

The Hotel plans to perform the following functions along Church Avenue at the existing curb cut south of the entrance doors (“Existing Curb Cut”) near the formal entrance to the Hotel.

- Security
- Bell Staff services for Hotel arrivals and departures and various other guest needs
- Valet for peak period Hotel arrivals and restaurant demand
- Hotel Drop-off
- Ride-Share
- Deliveries & Shipments

Below is the proposed operational plan along Church Avenue:

Deliveries:

It is anticipated that the Hotel will schedule large truck deliveries that cannot use the garage loading dock at the Existing Curb Cut. These deliveries will be pre-scheduled with vendors and will not take place during Peak Hours.

Valet:

Valet will be provided during select evening and weekend times as stated below. While there may be limited overlap with the Peak Hours, valet will be a more efficient operation than having Hotel/restaurant guests driving around downtown trying to get into the parking garage during the Peak Hours. Valet can efficiently assist guests to get off the roads during this time and drive the cars into the garage. Valet will be primarily to accommodate the restaurant demand, as well as a limited amount of evening Hotel arrivals and departures. Given the adjacent rail transit, ride-share and other transportation trends, the drive-to demand is not anticipated to be a high percentage for Hotel guests (less than 30%).

Valet would be positioned at the Existing Curb Cut to allow for proper circulation. Once a car is dropped and passengers unloaded, the valet route would be: Northbound to turn left/west on Congress (with enough time to get into the left turn lane), south/U-turn onto Broadway, and then east to the Parking

OPWEST | PARTNERS

Garage entrance. Because the valets will know this route, efficient maneuvering to the garage to get those cars off the streets during Peak Hours is expected.

Valet would operate Wednesday, Thursday, Friday evenings from 5pm-10pm. Weekends from 9 am-10 pm. The Hotel will continually assess the demands of valet and may modify the service times accordingly. Modifications will be coordinated with DTM as needed.

Ride-Share:

Ride share would utilize the Existing Curb Cut when available.

Increase of Public Parking:

The Hotel intends to provide public parking in the parking garage, which is currently a private garage that has not historically been open to the public. This added capacity will help offset any reduction in public parking along Church and will increase the parking capacity downtown.

ONE SOUTH CHURCH HOTEL — Tucson, AZ

Special Districts Application

JUNE 16, 2021

NELSENPARTNERS.COM



**NELSEN
PARTNERS**
ARCHITECTS & PLANNERS

PROJECT STATEMENT

THE EXTERIOR SCOPE INCLUDES FACADE IMPROVEMENTS TO THE WEST BUILDING ENTRANCE AND A NEW RESTAURANT PATIO WITH AWNINGS ALONG THE EAST SIDE OF THE BUILDING.

REFER TO ATTACHED PROJECT STATEMENT “1SC_IID USC REQUIREMENTS” OUTLINING HOW THIS PROJECT COMPLIES WITH THE APPLICABLE DESIGN AND SITE GUIDELINES.

GENERAL NOTES

PARCEL: 117-12-103C
 LEGAL DESCRIPTION: PUEBLO CENTER REDEVELOPMENT PROJECT ARIZONA R-8 BLK 509 PTN LOT 2
 EXISTING ZONING: OCR-2 / C-3
 GROSS LOT AREA: 31,726 SF / 0.73 AC
 EXISTING USE: OFFICE
 FUTURE PROPOSED USE: TRAVELERS ACCOMMODATION, LODGING OFFICE (CONVERTING LEVELS 1, 2, PORTION OF LEVEL 4, AND LEVEL S 5-9 FROM EXISTING OFFICE TO TRAVELERS ACCOMMODATION, LODGING)

PERCENTAGES
 GROSS FLOOR AREA: 54%
 LAND AREA: 44%
 VEHICULAR USE AREA: 2%

EXISTING PARKING
 EXISTING PARKING GARAGE WILL NOT BE MODIFIED WITH THIS SUBMITTAL.
 EXISTING LOADING ZONE LOCATED IN PARKING LEVEL P1 AND WILL NOT BE MODIFIED WITH THIS SUBMITTAL.
 EXISTING REFUSE COLLECTION AREA LOCATED IN PARKING LEVEL P1 WILL NOT BE MODIFIED WITH THIS SUBMITTAL.
EXISTING BICYCLE PARKING
 EXISTING BICYCLE PARKING WILL NOT BE MODIFIED WITH THIS SUBMITTAL.
 ALL SIGNAGE WILL REQUIRE A SEPARATE REVIEW AND PERMIT

Nelson Partners, Inc.
 Austin | Scottsdale
 15210 North Scottsdale Road
 Suite #300
 Scottsdale, Arizona 85254
 t 480.949.6800
 nelsonpartners.com

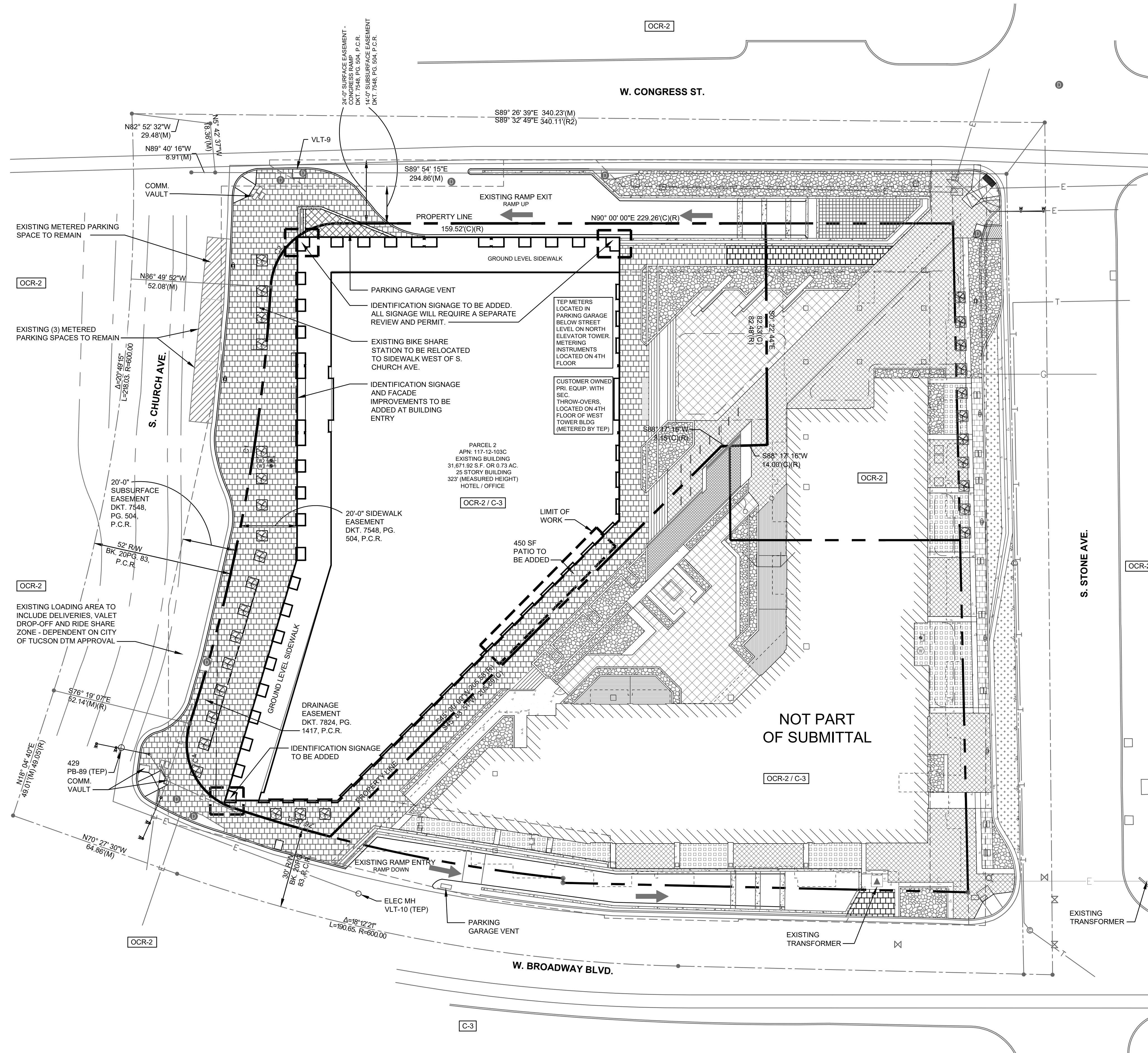

1 SOUTH CHURCH HOTEL

1 SOUTH CHURCH AVENUE
 TUCSON, ARIZONA

Date: JUNE 17, 2021
 Legal Description: PUEBLO CENTER REDEVELOPMENT PROJECT ARIZONA R-8 BLK 509 PTN LOT 2, BEING A PORTION OF SECTION 12, T14S, R13E G&SRM
 Owner: OPWEST PARTNERS 6900 E. CAMELBACK RD., SUITE 902 SCOTTSDALE, AZ 85251 (W) 480-470-9200 (M) 602-672-9380 ATTN: TYLER KENT
 Architect: NELSEN PARTNERS 15210 N. SCOTTSDALE RD #300 SCOTTSDALE, AZ 85254 480-949-6800

Drawings and written material appearing herein constitute original and unpublished work of the architect and may not be duplicated, used, or disclosed without written consent of the architect.
 © 2020 NELSEN PARTNERS, INC.

Project No. 319043
A110
 SITE PLAN

57'-0"
5TH FLOOR

44'-0"
4TH FLOOR

31'-0"
3RD FLOOR

18'-0"
2ND FLOOR

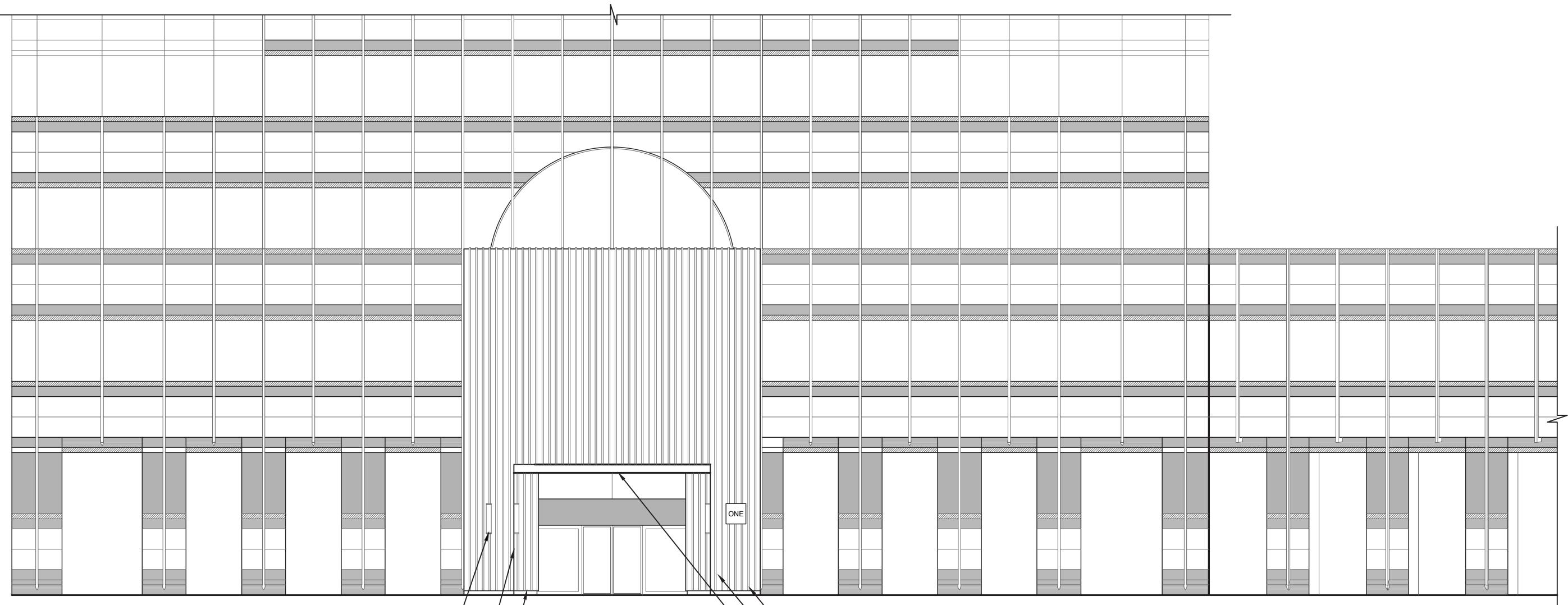

DECORATIVE LIGHT FIXTURE

ANTIQUE MIRROR (ON INSIDE FACE)

BLACK STEEL BASE

ONE

BLACK (PREFINISHED) METAL FIN

WHITE TEXTURED PLASTER

DARK WOOD VENEER

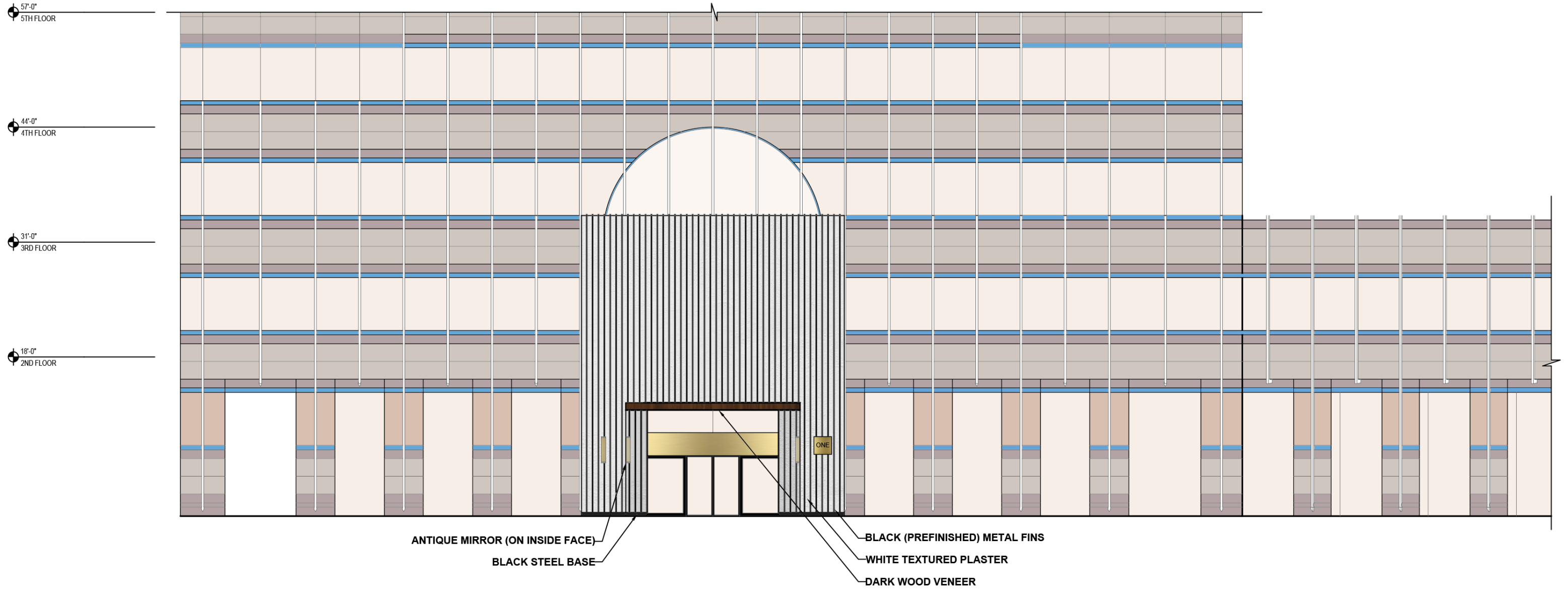





PREFINISHED BLACK METAL FINS

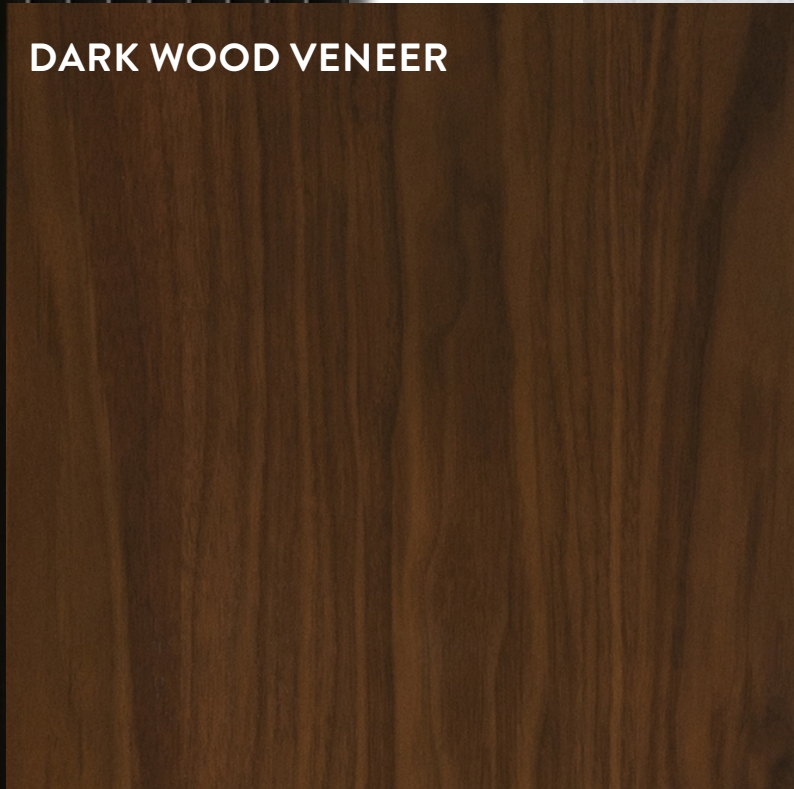

DARK WOOD VENEER



WHITE TEXTURED PLASTER FINISH



BLACK STEEL BASE

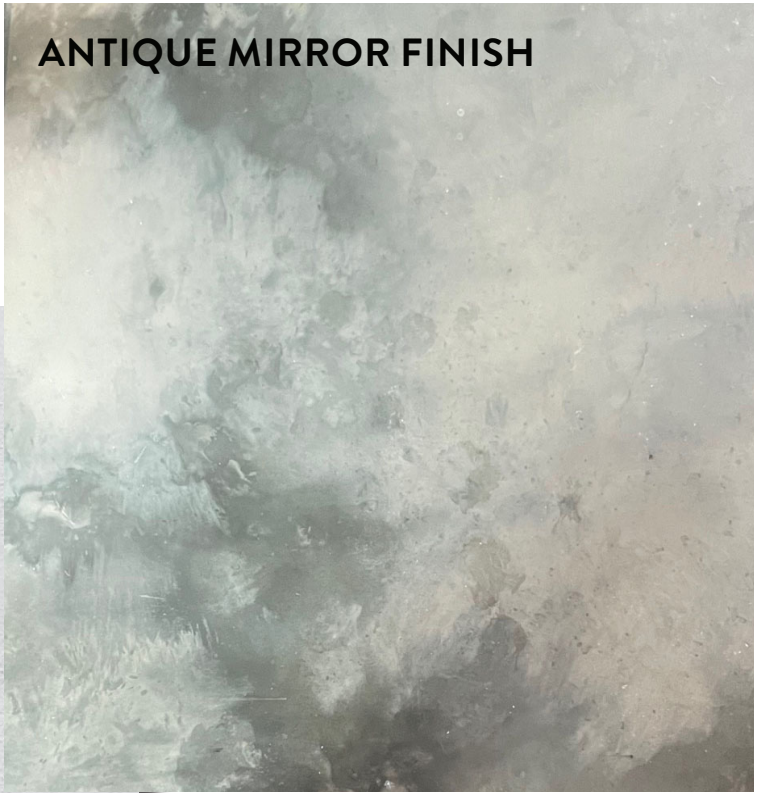

ANTIQUE MIRROR FINISH

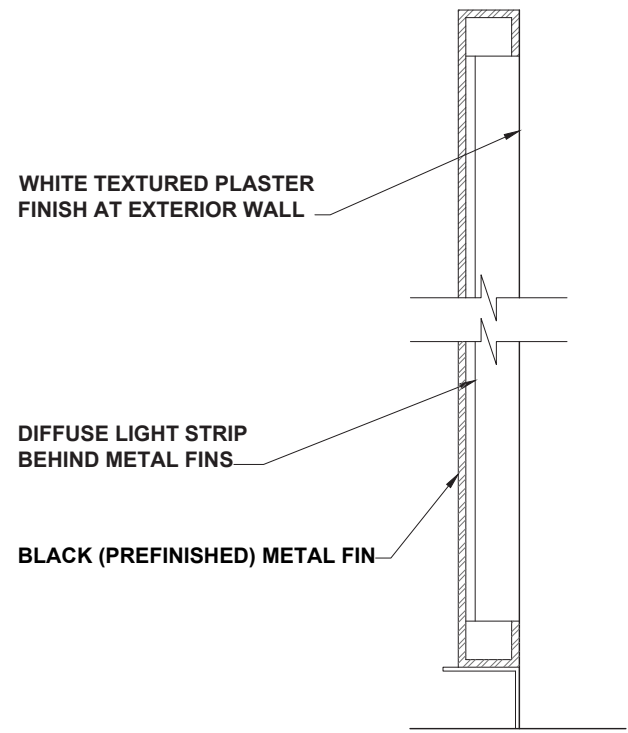

LIGHTING AT METAL FINS - DETAIL

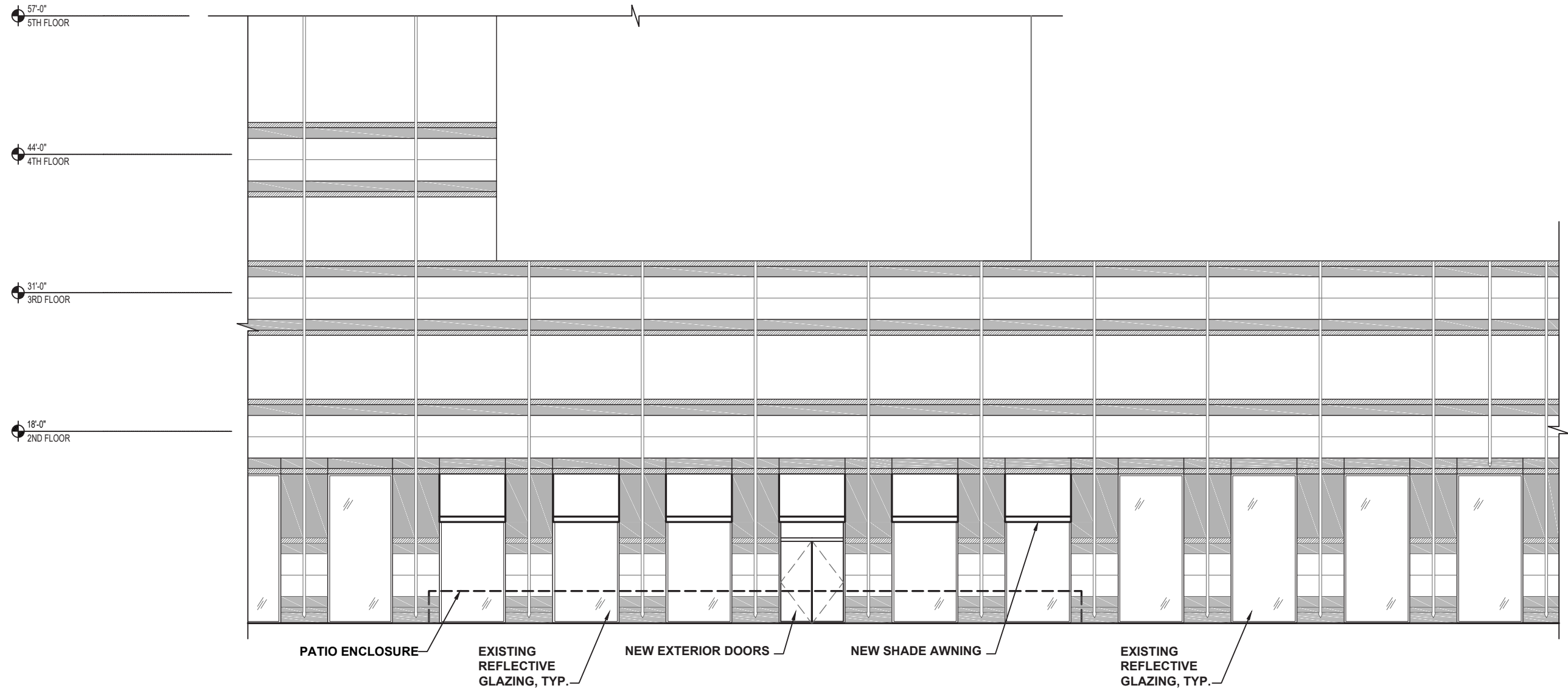

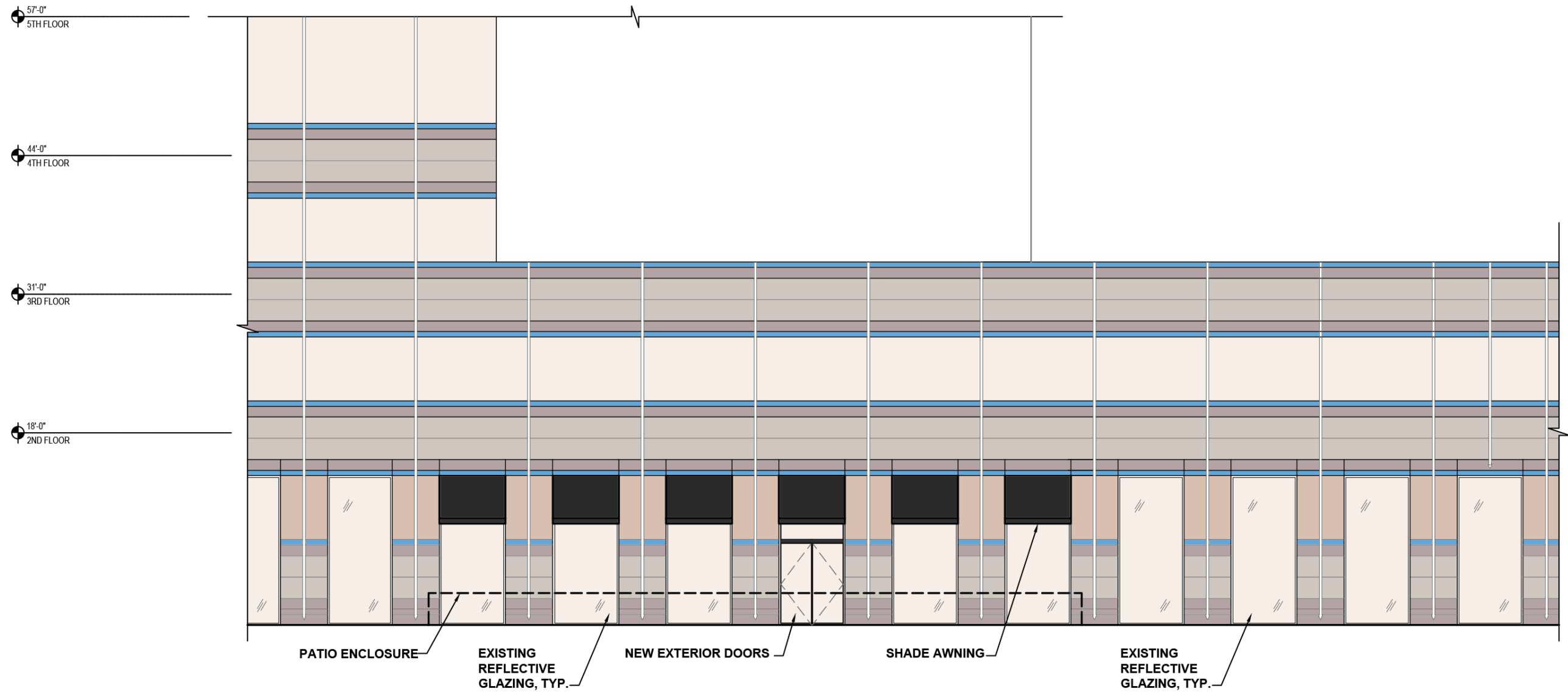



PROJECT INFORMATION

PROJECT NAME: ONE SOUTH CHURCH BOUTIQUE HOTEL
 PARCEL ADDRESS: 1 SOUTH CHURCH AVE
 TUCSON, AZ 85701
 LEGAL DESCRIPTION: PUEBLO CENTER
 REDEVELOPMENT PROJECT ARIZONA R-8
 BLK 506 LOT 1 PTN LOT 2
 PARCEL NUMBER: 117-12-103C
 EXISTING ZONING: OCR-2 / C-3 / RIO NUEVO IID
 CASE NUMBER: DP20-0164

SHADE STUDY DATA @ JUNE 21 AT 2 PM

TOTAL AREA OF SIDEWALK AT:
 NORTH: 2,791 SF
 SOUTH, EAST, SOUTHEAST: 6,225 SF
 WEST: 8,998 SF
 TOTAL AREA OF SHADE AT:
 NORTH: 2,630 SF (97.2%)
 SOUTH, EAST, SOUTHEAST: 6,225 SF (100%)
 WEST: 2,637 (27.3%)
 TOTAL AREA OF SIDEWALK: 18,014 SF
 TOTAL AREA OF SHADED SIDEWALK: 11,492
 TOTAL PERCENT OF SHADED SIDEWALK: 61.8%

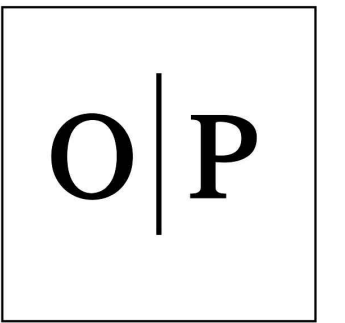
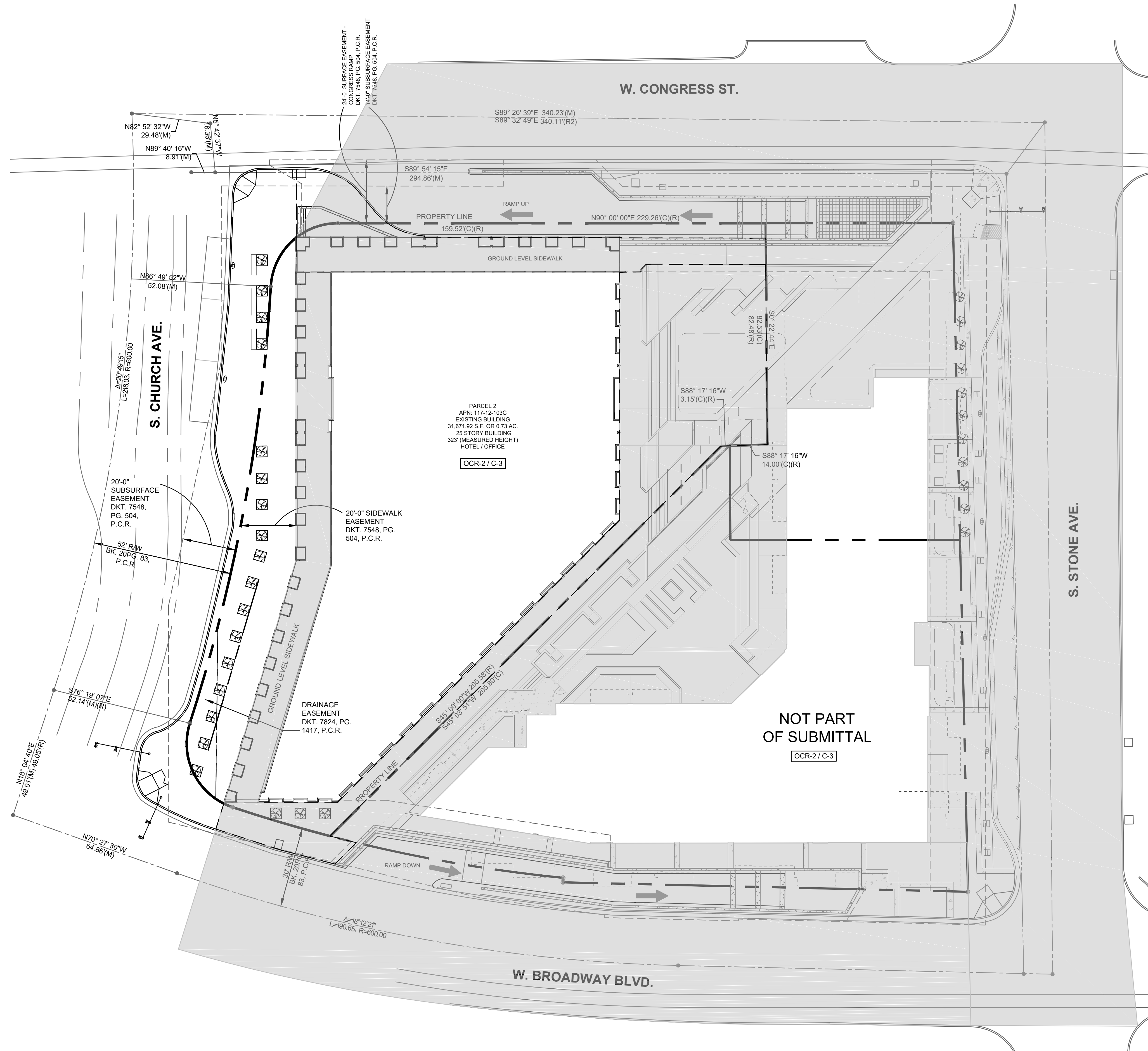

TRIBUTE PORTFOLIO

ONE SOUTH CHURCH
 BOUTIQUE HOTEL
 1 SOUTH CHURCH AVENUE
 TUCSON, ARIZONA

Date
 July 16, 2021
 Revisions

Drawings and written material appearing herein constitute original and unpublished work of the architect and may not be duplicated, used, or disclosed without written consent of the architect.
 © 2021 NELSEN PARTNERS, INC.



VEINTE DE AGOSTO PARK

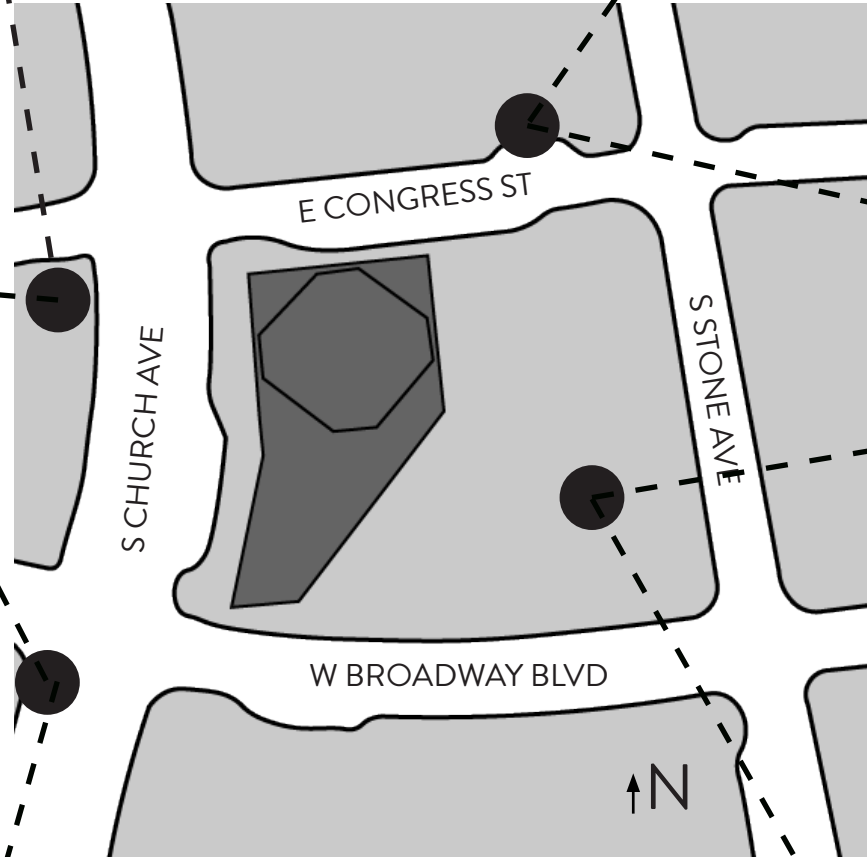

HISTORIC FOX THEATER



HEALTH ALLIANCE BUILDING



RENDEZVOUS APARTMENTS

NELSEN PARTNERS, INC.
Austin | Scottsdale

—
15210 North Scottsdale Road
Suite 300
Scottsdale, Arizona 85254
480.949.6800

Principals

Brad J. Nelsen, ^{AIA, RAIA}
Philip J. Crisara, ^{AIA}
George A. Melara, ^{AIA}
Erston Senger, ^{AIA}

Directors

Jeff Brand, ^{AIA}
J. Scott Chasteen
Scott DeMont, ^{AIA}
Michael Martin, ^{AIA}
Carson Nelsen
Stephen L. Oliva, ^{AIA}

Associates

Lindsay Abati, ^{AIA}
Matthew Beaton, ^{AIA}
Stephen Hunt, ^{AIA}
Randy McManus
Bob Newell, ^{AIA}
Janet Quan
Sandra Saldaña

One South Church Hotel

DP20-0164

Parcel: 117-12-103C

UDC § 5.12.7: Rio Nuevo Design Criteria Responses

Below is an excerpt from the UDC of the Rio Nuevo Design Standards. Most of these standards do not apply since the 1 S. Church building is not being significantly revised with this application. The building is primarily preserved and adaptively reused with only minor changes.

C. Building Design Standards

Development within the RNA is required to comply with the following building design standards.

1. The proposed buildings shall respect the scale of those buildings located in the development zone and serve as an orderly transition to a different scale pursuant to Section [5.12.8.B](#), *Development Transition Standards*. Building heights with a vastly different scale than those on adjacent properties should have a transition in scale to reduce and mitigate potential impacts. In areas undergoing change, long range plans should be consulted for guidance as to appropriate heights;

Not applicable as building scale is not being modified.

2. All new construction must be consistent with the prevailing setback existing within its development zone except that the PDS Director may approve a different setback than the prevailing setback upon a written finding during the review process that a different setback is warranted by site conditions or applicable development design goals consistent with Section [5.12.1](#), *Purpose*, and the proposed setback will not be incompatible with adjacent properties, as defined in Section [11.4.2.A](#);

Not applicable as no new construction is planned within the existing setback.

3. All new construction shall provide scale defining architectural elements or details at the first two floor levels, such as windows, spandrels, awnings, porticos, cornices, pilasters, columns, and balconies;

Façade improvements are all modifications to the existing building. The restaurant patio includes shade awnings above the existing 1st floor exterior windows and the

west entry façade improvement includes an antique mirrored threshold at the pedestrian level.

4. Every commercial building frontage shall provide windows, window displays, or visible activity within and adjacent to the building at the ground floor level, with a minimum of 50 percent of the building frontage providing such features;

Not applicable as the building frontage is existing and is not being modified with the exception of the west entry.

5. A single plane of a façade at the street level may not be longer than 50 feet without architectural relief or articulation by features such as windows, trellises, and arcades;

Not applicable as the building façade is existing and already includes windows and arcades.

6. Building façade design shall include pedestrian-scaled, down-shielded, and glare controlled exterior building and window lighting;

The decorative light fixtures at the west entry and patio will be pedestrian scaled, down-shielded, and glare controlled. The lighting behind the metal fins at the west entry will be scale-appropriate and directionally shielded to avoid glare.

7. The front doors of all commercial and government buildings shall be visible from the street and visually highlighted by graphics, lighting, marquees, or canopies;

Not applicable as the front door of the building is existing and is not being modified.

8. Modifications to the exterior of historic buildings shall complement the overall historic context of the Downtown and respect the architectural integrity of the historic façade;

Not applicable as this is not listed as a historic building.

9. Buildings shall be designed to shield adjacent buildings and public rights-of-way from reflected heat and glare;

Not applicable as the building is existing.

10. Safe and adequate vehicular parking areas designed to minimize conflicts with pedestrians and bicycles shall be provided;

An existing parking garage is located below grade and is not being modified.

11. Adequate shade shall be provided for sidewalks and pedestrian pathways, using shade structure or vegetation, where permitted by the City;

The existing pedestrian pathway between the One South Church building and the adjacent apartment building is currently shaded by both structures during much of the day. No new pedestrian pathways or sidewalks are planned as part of this submittal.

12. Colors may conform to the overall color palette and context of the Downtown area or may be used expressively to create visual interest, variety, and street rhythms. The rationale for an expressive or idiosyncratic use of color shall be described in the site plan submittal;

No idiosyncratic or expressive colors are included in the building modifications. The west entry façade improvement creates visual interest through the use of a variety of high quality materials and neutral colors that are complementary to the existing building façade.

13. New buildings shall use materials, patterns, and elements that relate to the traditional context of the Downtown area;

Not applicable as the building is existing.

14. Twenty-four-hour, street -level activity is encouraged by providing a mixture of retail, office, and residential uses within each building; and,

While the building is existing and some uses already established, this adaptive reuse is intended to increase the mix of uses and provide street level activity in a building that was primarily office. With the addition of the hotel and restaurant / patio seating, the mix of uses on this block is now more diversified (residential / office / hospitality and restaurant) with more street level activity opportunity.

15. Primary public entries shall be directly accessed from a sidewalk along a street rather than from a parking lot. Public access to commercial and governmental buildings shall be provided at sidewalk grade. The primary floor of, and access to, residential structures may be elevated. Secondary access may be provided from off-street parking areas.

Although this criteria is not applicable since the building is existing, this goal has been achieved with the original building as the primary public entries are at the ground level from accessible sidewalks on both sides of the building with secondary access to the parking garage.

D. Site Design Standards

1. Vehicular Circulation

a. All parking area access lanes (PAALs) adjacent to buildings shall have pedestrian circulation paths between the PAAL and the building, with a minimum width of six feet.

b. The locations of all points of vehicular ingress and egress shall be perpendicular to the intersecting street. Points of ingress and egress points shall be designed to minimize vehicular/pedestrian and vehicular/bicycle conflicts. Adequate storage for vehicular queuing at parking facilities shall be contained on site. Right turn bays are strongly discouraged. Points of ingress and egress shall be minimized wherever possible. Additional temporary ingress and egress locations may be permitted for parking structures when occasional high peak period traffic flows (i.e., parking facilities for event venues) are anticipated.

Not applicable as all parking areas are existing.

2. Parking

a. General Parking standards are listed in Section [7.4](#). Some properties in the RNA may also be located in the Downtown Parking District , which allows a reduction in the number of parking spaces as provided in Section [7.4.5.B](#).

b. Screening of Parking All new parking shall be designed so that vehicles are not visible from the adjoining street level, through incorporation of pedestrian arcades, occupied space, or display space.

c. Employee Parking Employee parking for all uses should be provided at remote locations in order to maximize the availability of space for development.

Not applicable as all parking areas are existing.

3. Plazas and Open Space

The fundamental objective of the design standards in this Section [5.12.7.D.3](#) is to encourage public and private investments to enhance the character and function of Downtown's pedestrian environment.

a. Plazas and Pedestrian Nodes

Five percent of the gross floor area of new construction shall be provided in public plazas or courtyards. Open space plazas, courtyards, and patios are landscaped outdoor areas designed to accommodate multiple uses, from large gatherings of the

people for performing arts to smaller gatherings. The plazas and courtyards will be one of the ways that spaces and uses can be linked. The requirement of this section may be waived or reduced by the PDSD Director upon a written finding during the review process that the development enhances the downtown pedestrian environment even with a smaller percent or elimination of the requirement.

Not applicable since existing building and plaza spaces remain. However, there is a space between the existing building and the new residential building that acts as a gathering area open to the public. The addition of the restaurant patio seating area will help to activate that space.

b. Viewshed Corridors

Views of all historic properties and all natural elements surrounding the Downtown should be considered during design. Plazas, courtyards, and open spaces shall be sited to include views to other public spaces, where feasible.

Not applicable as the building and adjacent plaza are existing.

c. Linkages (Physical and Visual)

Neighborhood linkages shall be maintained throughout Downtown.

Not applicable as the building and adjacent plaza are existing.

4. Streetscape

a. Streetscapes must be consistent with the Streetscape Design Policy. In streetscape design, priority is given to pedestrians.

Not applicable as the streetscape is existing and is not being modified.

b. Shade

Shade shall be provided for at least 50 percent of all sidewalks and pedestrian pathways as measured at 2:00 p.m. on June 21 when the sun is 82° above the horizon (based on 32°N Latitude). Shade may be provided by arcades, canopies, or shade structures, provided they and their location and design characteristics are compatible with the prevailing and design context of the street and the architectural integrity of the building. Deciduous trees, as proposed in the Downtown Comprehensive Street Tree Plan, are encouraged to supplement existing evergreen trees. The use of plantings and shade structures in the City right-of-way are permitted to meet this standard with the approval of the Department of Transportation. The shade provided by a building may serve to meet this standard.

The building and adjacent plaza are existing, as are all sidewalks and pedestrian pathways. The existing sidewalks and pedestrian pathways are not being modified. The existing building arcade shades 100% of the pedestrian pathway along the north and west frontages of the building. At 2pm on June 21st, the north and south streetscapes (including sidewalks) are fully shaded by the building or adjacent buildings. The west streetscape and sidewalk is not shaded at this time. The north and south streetscapes accomplish the 50% shading requirement.

Permit Review Details

Permit: DP20-0164
Parcel: 11712103C

Review Details

Addresses:
1 S CHURCH AV

Review Status: **Active**

Show entries

Search:

Task End Date	Reviewer's Name	Type of Review	Description	Status	Comment
8/21/2020	ANY	COT NON-DSD	REAL ESTATE	Active	None
8/21/2020	SBEASLE1	UTILITIES	TUCSON ELECTRIC POWER	Reqs Change	<p>(The TEP FACILITIES MAP mentioned below and a TEP REVIEW document can be viewed online: www.TucsonAz.gov/Pro. See the Documents section.)</p> <p>August 24th, 2020</p> <p>SUBJECT: One South Church Hotel, DP20-0164</p> <p>Tucson Electric Power Company (TEP) has reviewed the development plan submitted August, 21, 2020 TEP is unable to approve the plan at this time. TEP has facilities on the South and West side of 1 S. Church Ave. that are not depicted in the plans.</p> <p>Enclosed is a copy of a TEP facility map showing the approximate location of the existing facilities. All costs associated with the relocation of the facilities in conflict will be billable to the developer.</p> <p>Please resubmit a revised blueline to the City of Tucson for TEP's review. Should you have any technical questions, please contact the area Designer, Cruz Vega, at (520) 349-9850 should you have any questions.</p> <p>Sincerely, Conor Mahoney, Office Support Assistant Design/Build</p>
8/21/2020	ANY	ZONING-DECISION LETTER	REVIEW	Active	None
8/21/2020	SBEASLE1	START	PLANS SUBMITTED	Completed	None
8/21/2020	SBEASLE1	OTHER AGENCIES	U. S. POST OFFICE	Passed	None
8/21/2020	SBEASLE1	OTHER AGENCIES	PIMA ASSN OF GOVTS	Passed	None
8/21/2020	SBEASLE1	UTILITIES	SOUTHWEST GAS	Passed	None
8/21/2020	SBEASLE1	ENGINEERING	REVIEW	Passed	Passed by Loren Makus, 08/20/20 during OK to Submit.
8/21/2020	TOM MARTINEZ	OTHER AGENCIES	AZ DEPT TRANSPORTATION	Approved	<p>ADOT South Central District has no comments and/or concerns for this project; due to the development location. It will pose no impact upon the state system.</p> <p>Richard La Pierre Permits Supervisor, South Central District 1221 South Second Avenue, Tucson, Arizona 85713 520.388.4234 (office)</p>
8/25/2020	ROBERT SHERRY	PLUMBING-COMMERCIAL	REVIEW	Completed	None

Showing 1 to 10 of 19 entries

Previous 2 Next

Permit Review Details

Permit: DP20-0164
Parcel: 11712103C

Review Details

Addresses:
1 S CHURCH AV

Review Status: **Active**

Show entries

Search:

Task End Date	Reviewer's Name	Type of Review	Description	Status	Comment
8/26/2020	MGAYOSS1	DESIGN PROFESSIONAL	REVIEW	Needs Review	8/26/2020 - Review by Maria Gayosso. Project is located in the Infill Incentive District - Rio Nuevo Area. Applicant has not filed an application RNA or IID for review.
9/3/2020	SBEASLE1	COT NON-DSD	ENVIRONMENTAL SERVICES	Approved	EGSD has no comments regarding One South Church Hotel, DP20-0164, 1st submittal There appears to be nothing proposed or relative to solid waste collection and disposal requirements. Thanks, Andy Vera City of Tucson - Environmental Services Accounts Representative Supervisor (520) 837-3798
9/8/2020	GDAURIA1	COT NON-DSD	FIRE	Approved	None
9/16/2020	SBEASLE1	COT NON-DSD	PARKS & RECREATION	Approved	No existing or proposed Tucson Parks and Recreation facilities are affected by this development. Howard B. Dutt, RLA, Landscape Architect Tucson Parks and Recreation, (520) 837-8040

Task End Date	Reviewer's Name	Type of Review	Description	Status	Comment
9/21/2020	ANDREW CONNOR	LANDSCAPE	REVIEW	Reqs Change	<p>ADMINISTRATIVE MANUAL</p> <p>Identification and Descriptive Data</p> <p>All improvements and site information, such as adjacent rights-of-way and property lines, shown on the landscape plan will be identical in size and location to those shown on the base plan (site plan or tentative plat). Should amendments be required to the base plan through the review process, the same amendments will be made to the landscape plan which will then be resubmitted along with the base plan.</p> <p>The Development Package will contain the following identification in the lower right corner of each sheet:</p> <p>Any relevant case numbers for reviews or modifications that affect the site.</p> <p>Provide Case # DP20-0164 on each sheet.</p> <p>The site is within the following Overlay District:</p> <p>Infill Incentive District</p> <p>DOWNTOWN CORE SUBDISTRICT</p> <p>LANDSCAPING AND SCREENING</p> <p>A complete or partial exception to the landscaping and screening requirements in Section 7.6 may be granted by the PSD Director, if shade along sidewalks, pedestrian circulation paths or outdoor patios is provided for pedestrians and customers in accordance Section 5.12.6.A.2. Alternative pedestrian access that creates connectivity between public entrances to the project and abutting sidewalk is allowed if no safety hazard is created. All pedestrian access must conform to the accessibility standards of the City's Building Code.</p> <p>Ensure that Zoning, Engineering and Design Professional comments are addressed prior to landscape section approval.</p> <p>Additional comments may apply</p>
9/21/2020	ZELIN CANCHOLA	COT NON-DSD	TRAFFIC	Reqs Change	<p>DP20-0164 September 21, 2020 Zelin Canchola Transportation and Mobility Engineering</p> <p>The plan requires change. Perk Tucson has provided comments concerning parking and loading zones. Please contact Prk Tucson for requirements.</p> <p>From Donovan Durband:</p> <p>I'm concerned about losing the freight loading zone for that block. The remaining office businesses in the tower would need a delivery zone, I'm sure, and so would the hotel. An option would be to co-locate the valet/ride-hailing zone with both the freight loading zone in its current location and the metered parking in its current location. The metered parking spaces could be designated for valet and passenger loading/unloading after 5pm and on weekends, and the freight loading could be time-limited to mornings, allowing that zone to be used for other deliveries and passenger loading/unloading the remainder of the time (afternoons, evenings, weekends).</p> <p>Donovan Durband, M.S., CAPP Administrator, Park Tucson City of Tucson Department of Transportation & Mobility Donovan.Durband@tucsonaz.gov www.ParkTucson.com</p> <p>Zelin Canchola zelin.canchola@tucsonaz.gov</p>
9/22/2020	JOE LINVILLE	COT NON-DSD	LANDSCAPE	Needs Review	Needs TDOT review.
9/25/2020	STEVE SHIELDS	ZONING	REVIEW	Reqs Change	<p>CDRC TRANSMITTAL</p> <p>TO: Development Services Department</p>

Task End Date	Reviewer's Name	Type of Review	Description	Status	Comment
					<p>Plans Coordination Office</p> <p>FROM: Steve Shields Site Section Manager</p> <p>PROJECT: 1 South Church Hotel Development Package (1st Review) DP20-0164</p> <p>TRANSMITTAL DATE: September 25, 2020</p> <p>DUE DATE: September 21, 2020</p> <p>COMMENTS: Please resubmit revised drawings and any redlined plans along with a detailed response letter, which states how all Zoning Review Section comments were addressed.</p> <p>This plan has been reviewed for compliance with the Unified Development Code (UDC) Administrative Manual (AM) Section 2-06. Also, compliance with applicable development criteria for the proposed use as listed in the City of Tucson Uniform Development Code (UDC) and the UDC Technical Standards Manual (TSM).</p> <p>The review comments include the applicable Administrative Manual section number and the following paragraph is the actual comment related to the specific item that must be addressed. If you need to review the sections listed below click on the link or copy it in the address bar of your internet program. http://www.amlegal.com/nxt/gateway.dll/Arizona/tucson_az_udc/administrativemannual?f=templates\$fn=default.htm\$3.0\$vid=amlegal:tucson_udc_az</p> <p>This link will take you directly to the section used for the standards review. The UDC & TSM requirements are in the Unified Development Code and can be viewed at the same web link as above</p> <p>Section 3.3.3.G.5.c UDC, an applicant has one year from the date of application to obtain approval of a site plan that complies with zoning and other development requirements in effect at the time of application, unless an ordinance adopted by Mayor and Council during this period states otherwise. A site plan application that has been in review for a period of one year and has not yet been approved is considered denied. To continue the review of a site plan for the property, a new site plan must be submitted that complies with regulations in effect at the time of re-submittal. The new submittal initiates a new one-year review period. One-year Expiration date is August 20, 2021.</p> <p>SECTION 2-06.0.0: DEVELOPMENT PACKAGE (TENTATIVE PLATS AND SITE PLANS) Section</p> <p>2-06.1.0 GENERAL</p> <p>2-06.2.0 APPLICATION SUBMITTAL REQUIREMENTS</p> <p>2-06.3.0 FORMAT REQUIREMENTS</p> <p>2-06.4.0 CONTENT REQUIREMENTS</p> <p>2-06.5.0 FLEXIBLE LOT DEVELOPMENT (FLD) - ADDITIONAL REQUIREMENTS</p> <p>2-06.1.0 GENERAL</p> <p>2-06.1.1 PURPOSE This standard has been prepared for the purpose of informing applicants of the submittal and review requirements for development package documents to assure proper and adequate information is presented in a consistent manner, thereby providing the basis for an efficient and timely review. The development package documents are prepared in support of applications for building permits and related reviews.</p> <p>The information that is requested establishes the basis upon which the project will be approved and could affect what is required of the property in the future, should there be a proposal for expansion or for a different use of the property.</p> <p>This standard does not waive any applicable city regulations or codes.</p> <p>2-06.1.2 APPLICABILITY This standard shall be used for all site plans and tentative plats submitted to PSDS for review.</p> <p>2-06.2.1 APPLICATION SUBMITTAL REQUIREMENTS Development Package applications are available from PSDS. Completed applications and accompanying materials shall be submitted to PSDS. Incomplete or inaccurate applications will not be accepted, nor will any application in which the pre-application conference or neighborhood meeting requirements have not been met. The types of documents and the specific number of copies required of each of the documents are on the PSDS website or may be obtained from PSDS. Resubmittals of development packages require a comment response letter that details how all previous comments have been addressed. Provide the same number of copies of the comment response letter as plans provided. The following documents and information shall be submitted upon application:</p> <p>2-06.2.1 Application Form A completed application signed by the property owner or authorized designee;</p> <p>2-06.2.2 Development Package A development package must be prepared to the format and content requirements described herein;</p> <p>2-06.2.3 Related Reviews In addition to the plan process, a project may require review for other types of plans and documents. The applications for those processes are submitted to the appropriate department for review and approval. These related reviews can be applied for so that review can occur</p>

Task End Date	Reviewer's Name	Type of Review	Description	Status	Comment
					<p>concurrently with the development package application. However, it must be understood that, should the related application be approved subject to conditions or denied, this may affect the;</p> <p>2-06.2.4 Concurrent Reviews The development package is designed to allow for concurrent review of any site related reviews. Concurrent review means that all plans and documents needed for the review are submitted as one package. Examples of site related reviews include but are not limited to: site plans, landscape plans, NPPO plans, water harvesting plans, grading plans, SWPPP plans, floodplain use permits, and overlay reviews. Separate applications are often required for the different site related reviews even if the plans are submitted concurrently; and,</p> <p>2-06.2.5 Fees Fees in accordance with Section 4-01.0.0, Development Review Fee Schedule.</p> <p>2-06.4.0 CONTENT REQUIREMENTS</p> <p>1. 2-06.4.3 - Provide the Development Package case number, DP20-0164, adjacent to the title block on all sheets.</p> <p>2. 2-06.4.4 - The project-location map to be located on the first sheet of the development package in the upper right corner, shall cover approximately one square mile, be drawn at a minimum scale of three inch equals one mile</p> <p>3. 2-06.4.4.C - Section, township, and range; section corners; north arrow; and the scale will be labeled on the location map.</p> <p>2-06.4.7 - General Notes The following general notes are required. Additional notes specific to each plan are required where applicable.</p> <p>2-06.4.7.A - Zoning and Land Use Notes</p> <p>4. 2-06.4.7.A.4 - The proposed "HOTEL" use should be listed as "TRAVELERS ACCOMMODATION, LODGING".</p> <p>5. 2-06.4.7.A.6.a - As this site is located within the down town core and the Rio Nuevo Area (RNA) and you are proposing an exterior patio RNA & Historic review may be required. Contact Maria Gayosso, Maria.Gayosso@tucsonaz.gov for requirements and process.</p> <p>6. 2-06.4.7.A.6.b - If RNA or Historic review is required provide the case number adjacent to the title block on all sheets.</p> <p>2-06.4.7.A.8 - For development package documents provide:</p> <p>7. 2-06.4.7.A.8.a - Provide the floor area for the proposed patio on the plan.</p> <p>2-06.4.9 - Information on Proposed Development The following information on the proposed project shall be shown on the drawing or added as notes.</p> <p>8. 2-06.4.9.Q - Provide the square footage of the proposed patio within the footprint on the plan.</p> <p>9. 2-06.4.9.W - All signage will require a separate review and permit.</p> <p>If you have any questions about this transmittal, please Steve Shields, (520) 837-4956 or Steve.Shields@tucsonaz.gov</p> <p>RESUBMITTAL OF THE FOLLOWING IS REQUIRED: Revised development package</p>
9/25/2020	STEVE SHIELDS	ZONING	REVIEW	Reqs Change	<p>CDRC TRANSMITTAL</p> <p>TO: Development Services Department Plans Coordination Office</p> <p>FROM: Steve Shields Site Section Manager</p> <p>PROJECT: 1 South Church Hotel Development Package (1st Review) DP20-0164</p> <p>TRANSMITTAL DATE: September 25, 2020</p> <p>DUE DATE: September 21, 2020</p> <p>COMMENTS: Please resubmit revised drawings and any redlined plans along with a detailed response letter, which states how all Zoning Review Section comments were addressed.</p> <p>This plan has been reviewed for compliance with the Unified Development Code (UDC) Administrative Manual (AM) Section 2-06. Also, compliance with applicable development criteria for the proposed use as listed in the City of Tucson Uniform Development Code (UDC) and the UDC Technical Standards Manual (TSM).</p> <p>The review comments include the applicable Administrative Manual section number and the following paragraph is the actual comment related to the specific item that must be addressed. If you need to review the sections listed below click on the link or copy it in the address bar of your internet program. http://www.amlegal.com/nxt/gateway.dll/Arizona/tucson_az_udc/administrativemanual?f=templates\$fn=default.htm\$3.0\$vid=amlegal:tucson_udc_az</p> <p>This link will take you directly to the section used for the standards review. The UDC & TSM requirements are in the Unified Development Code and can be viewed at the same web link as above</p>

Task End Date	Reviewer's Name	Type of Review	Description	Status	Comment
					<p>Section 3.3.3.G.5.c UDC, an applicant has one year from the date of application to obtain approval of a site plan that complies with zoning and other development requirements in effect at the time of application, unless an ordinance adopted by Mayor and Council during this period states otherwise. A site plan application that has been in review for a period of one year and has not yet been approved is considered denied. To continue the review of a site plan for the property, a new site plan must be submitted that complies with regulations in effect at the time of re-submittal. The new submittal initiates a new one-year review period. One-year Expiration date is August 20, 2021.</p> <p>SECTION 2-06.0.0: DEVELOPMENT PACKAGE (TENTATIVE PLATS AND SITE PLANS) Section</p> <p>2-06.1.0 GENERAL</p> <p>2-06.2.0 APPLICATION SUBMITTAL REQUIREMENTS</p> <p>2-06.3.0 FORMAT REQUIREMENTS</p> <p>2-06.4.0 CONTENT REQUIREMENTS</p> <p>2-06.5.0 FLEXIBLE LOT DEVELOPMENT (FLD) - ADDITIONAL REQUIREMENTS</p> <p>2-06.1.0 GENERAL</p> <p>2-06.1.1 PURPOSE This standard has been prepared for the purpose of informing applicants of the submittal and review requirements for development package documents to assure proper and adequate information is presented in a consistent manner, thereby providing the basis for an efficient and timely review. The development package documents are prepared in support of applications for building permits and related reviews.</p> <p>The information that is requested establishes the basis upon which the project will be approved and could affect what is required of the property in the future, should there be a proposal for expansion or for a different use of the property.</p> <p>This standard does not waive any applicable city regulations or codes.</p> <p>2-06.1.2 APPICABILITY This standard shall be used for all site plans and tentative plats submitted to PDSO for review.</p> <p>2-06.2.1 APPLICATION SUBMITTAL REQUIREMENTS Development Package applications are available from PDSO. Completed applications and accompanying materials shall be submitted to PDSO. Incomplete or inaccurate applications will not be accepted, nor will any application in which the pre-application conference or neighborhood meeting requirements have not been met. The types of documents and the specific number of copies required of each of the documents are on the PDSO website or may be obtained from PDSO. Resubmittals of development packages require a comment response letter that details how all previous comments have been addressed. Provide the same number of copies of the comment response letter as plans provided. The following documents and information shall be submitted upon application:</p> <p>2-06.2.1 Application Form A completed application signed by the property owner or authorized designee;</p> <p>2-06.2.2 Development Package A development package must be prepared to the format and content requirements described herein;</p> <p>2-06.2.3 Related Reviews In addition to the plan process, a project may require review for other types of plans and documents. The applications for those processes are submitted to the appropriate department for review and approval. These related reviews can be applied for so that review can occur concurrently with the development package application. However, it must be understood that, should the related application be approved subject to conditions or denied, this may affect the;</p> <p>2-06.2.4 Concurrent Reviews The development package is designed to allow for concurrent review of any site related reviews. Concurrent review means that all plans and documents needed for the review are submitted as one package. Examples of site related reviews include but are not limited to: site plans, landscape plans, NPPO plans, water harvesting plans, grading plans, SWPPP plans, floodplain use permits, and overlay reviews. Separate applications are often required for the different site related reviews even if the plans are submitted concurrently; and,</p> <p>2-06.2.5 Fees Fees in accordance with Section 4-01.0.0, Development Review Fee Schedule.</p> <p>2-06.4.0 CONTENT REQUIREMENTS</p> <p>1. 2-06.4.3 - Provide the Development Package case number, DP20-0164, adjacent to the title block on all sheets.</p> <p>2. 2-06.4.4 - The project-location map to be located on the first sheet of the development package in the upper right corner, shall cover approximately one square mile, be drawn at a minimum scale of three inch equals one mile</p> <p>3. 2-06.4.4.C - Section, township, and range; section corners; north arrow; and the scale will be labeled on the location map.</p> <p>2-06.4.7 - General Notes The following general notes are required. Additional notes specific to each plan are required where applicable.</p> <p>2-06.4.7.A - Zoning and Land Use Notes</p>

Task End Date	Reviewer's Name	Type of Review	Description	Status	Comment
					4. 2-06.4.7.A.4 - The proposed "HOTEL" use should be listed as "TRAVELERS ACCOMMODATION, LODGING".
					5. 2-06.4.7.A.6.a - As this site is located within the down town core and the Rio Nuevo Area (RNA) and you are proposing an exterior patio RNA & Historic review may be required. Contact Maria Gayosso, Maria.Gayosso@tucsonaz.gov for requirements and process.
					6. 2-06.4.7.A.6.b - If RNA or Historic review is required provide the case number adjacent to the title block on all sheets.
					2-06.4.7.A.8 - For development package documents provide:
					7. 2-06.4.7.A.8.a - Provide the floor area for the proposed patio on the plan.
					2-06.4.9 - Information on Proposed Development The following information on the proposed project shall be shown on the drawing or added as notes.
					8. 2-06.4.9.Q - Provide the square footage of the proposed patio within the footprint on the plan.
					9. 2-06.4.9.W - All signage will require a separate review and permit.
					If you have any questions about this transmittal, please Steve Shields, (520) 837-4956 or Steve.Shields@tucsonaz.gov
					RESUBMITTAL OF THE FOLLOWING IS REQUIRED: Revised development package

Showing 11 to 19 of 19 entries

Previous 1 **2** Next

Deliver To:

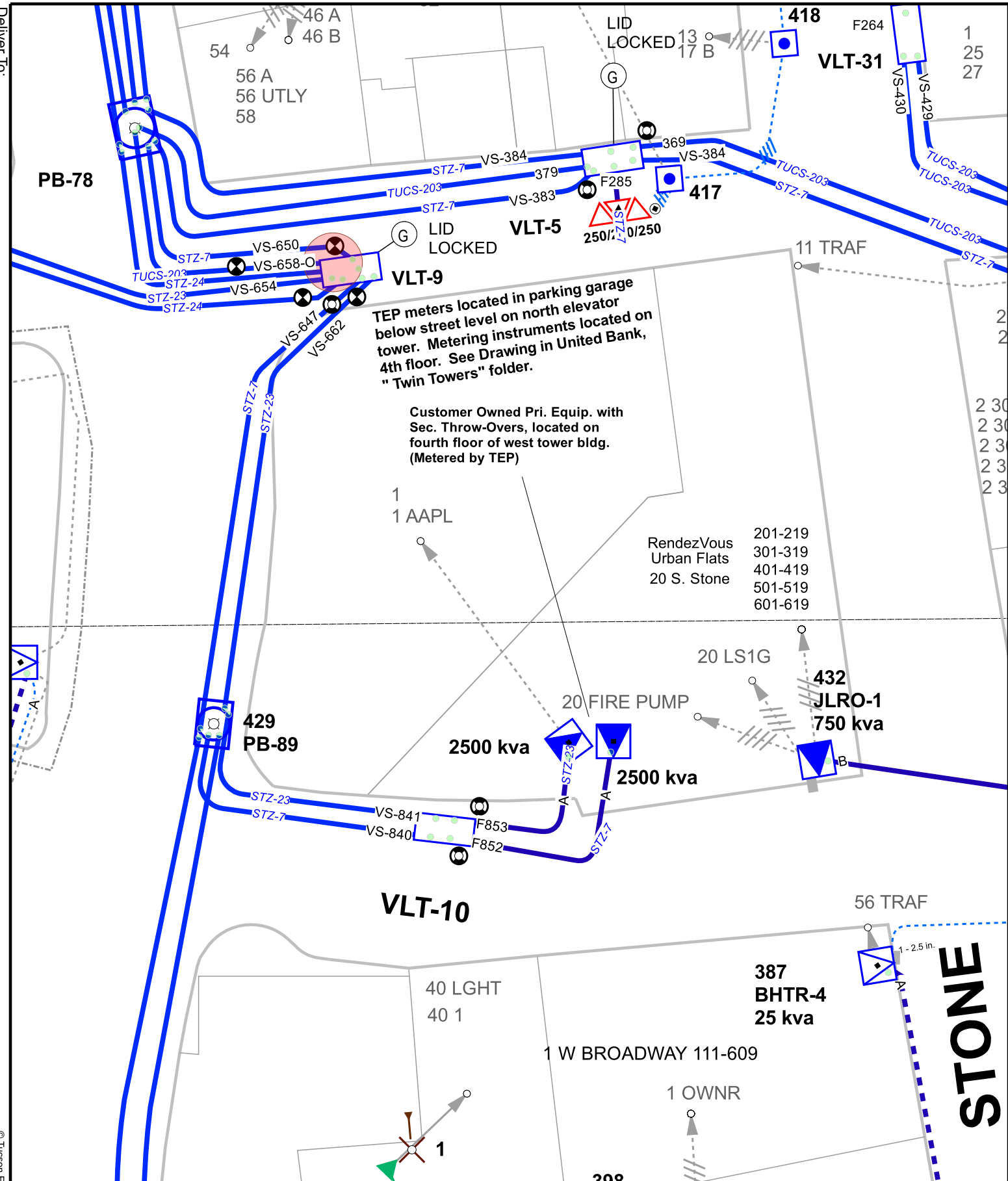

TEP meters located in parking garage below street level on north elevator tower. Metering instruments located on 4th floor. See Drawing in United Bank, "Twin Towers" folder.

Customer Owned Pri. Equip. with Sec. Throw-Over, located on fourth floor of west tower bldg. (Metered by TEP)

1
1 AAPL

RendezVous
Urban Flats
20 S. Stone
201-219
301-319
401-419
501-519
601-619

20 LS1G

20 FIRE PUMP
2500 kva
2500 kva

432
JLRO-1
750 kva

VLT-10

40 LGHT
40 1

1 W BROADWAY 111-609

1 OWNR

398

56 TRAF

387
BHTR-4
25 kva

STONE

© Tucson Electric Power Company 2020



Notes
:

The information contained herein is for informational purposes only, and is provided without warranty of any kind, expressed or implied, and without any guarantee as to accuracy or currency. The risk of using this information is assumed by the user and Tucson Electric Power Company shall not be liable for any damages arising

Date Plotted: 08/25/2020

SCALE: 1:712



Nelsen Partners, Inc.
Austin | Scottsdale

15210 North Scottsdale Road
Suite #300
Scottsdale, Arizona 85254
t 480.949.6800
nelsonpartners.com



Expires 12/31/2021

GENERAL NOTES

PARCEL: 117-12-099A
LEGAL DESCRIPTION: PUEBLO CENTER REDEVELOPMENT PROJECT ARIZONA R-8 BLK 509 PTN LOT 2
EXISTING ZONING: OCR-2 / C-3
GROSS LOT AREA: 31,726 SF / 0.73 AC
EXISTING USE: OFFICE
FUTURE PROPOSED USE: HOTEL / OFFICE (CONVERTING LEVELS 1, 2, PORTION OF LEVEL 4, AND LEVELS 5-9 FROM EXISTING OFFICE TO HOTEL)

PERCENTAGES
GROSS FLOOR AREA: 54%
LAND AREA: 44%
VEHICULAR USE AREA: 2%

EXISTING PARKING CALCULATIONS
* REFER TO EXISTING PARKING PLANS AS REFERENCE.

EXISTING PARKING GARAGE WILL NOT BE MODIFIED WITH THIS SUBMITTAL. THE EXISTING GARAGE WAS DESIGNED TO MEET THE REQUIREMENTS OF THE LAND USE CODE (LUC). ONLY THOSE PARKING SPACES WHICH MEET THE MINIMUM STANDARDS OF THE LUC ARE INCLUDED FOR THE PARKING CALCULATIONS WHICH INCLUDE ALL 'A' & 'B' TYPE SPACES, 'C' SPACES ARE IN ADDITION TO THOSE COUNTED.

SIZE	P1	P2	P3	TOTAL
FULL SIZE	109	122	124	355
COMPACT	18	22	22	51
NON-VIABLE	23	26	29	78

EXISTING LOADING ZONE LOCATED IN PARKING LEVEL P1 AND WILL NOT BE MODIFIED WITH THIS SUBMITTAL.

EXISTING REFUSE COLLECTION AREA LOCATED IN PARKING LEVEL P1 WILL NOT BE MODIFIED WITH THIS SUBMITTAL.

EXISTING BICYCLE PARKING
* REFER TO EXISTING PARKING PLANS AS REFERENCE.

EXISTING BICYCLE PARKING WILL NOT BE MODIFIED WITH THIS SUBMITTAL. LONG-TERM BICYCLE PARKING REQUIREMENTS FOR THIS PROJECT SHALL BE MET USING VERTICAL BICYCLE LOCKERS INSTALLED ON THE PARKING GARAGE LEVELS BELOW GRADE.

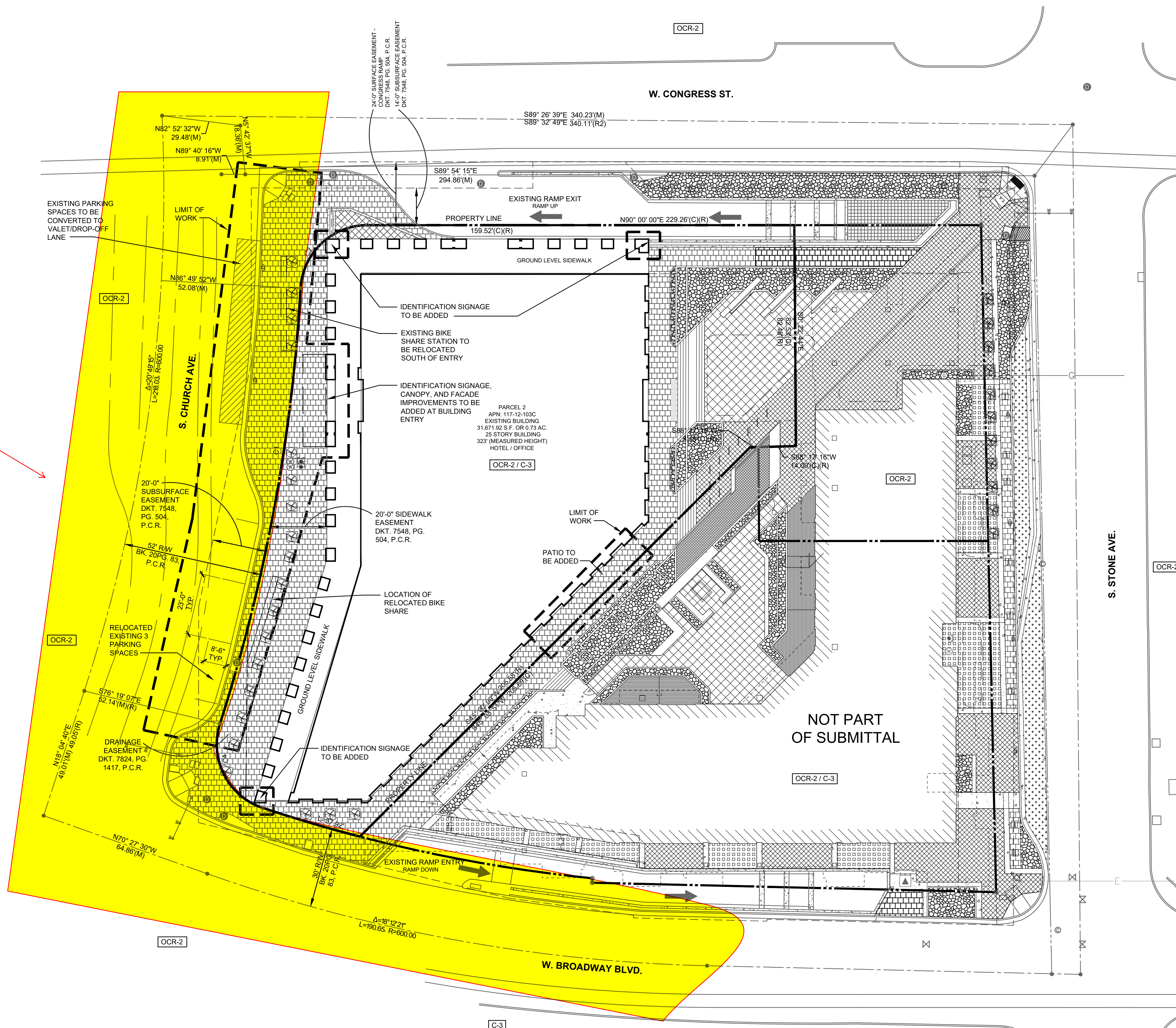

No TEP facilities shown in design

1 SOUTH CHURCH HOTEL

1 SOUTH CHURCH AVENUE
TUCSON, ARIZONA

Date
AUGUST 10, 2020

Legal Description
PUEBLO CENTER REDEVELOPMENT PROJECT ARIZONA R-8 BLK 509 PTN LOT 2, BEING A PORTION OF SECTION 12, T14S, R13E G&SRM

Owner
OPWEST PARTNERS
6900 E. CAMELBACK RD., SUITE 902
SCOTTSDALE, AZ 85251
(W) 480-470-9200
(M) 602-672-9380
ATTN: TYLER KENT

Architect
NELSEN PARTNERS
15210 N. SCOTTSDALE RD #300
SCOTTSDALE, AZ 85254
480-949-6800

Drawings and written material appearing herein constitute original and unpublished work of the architect and may not be duplicated, used, or disclosed without written consent of the architect.

© 2019 NELSEN PARTNERS, INC.

Project No.
319043

A110
SITE PLAN
SHEET 02 OF 07

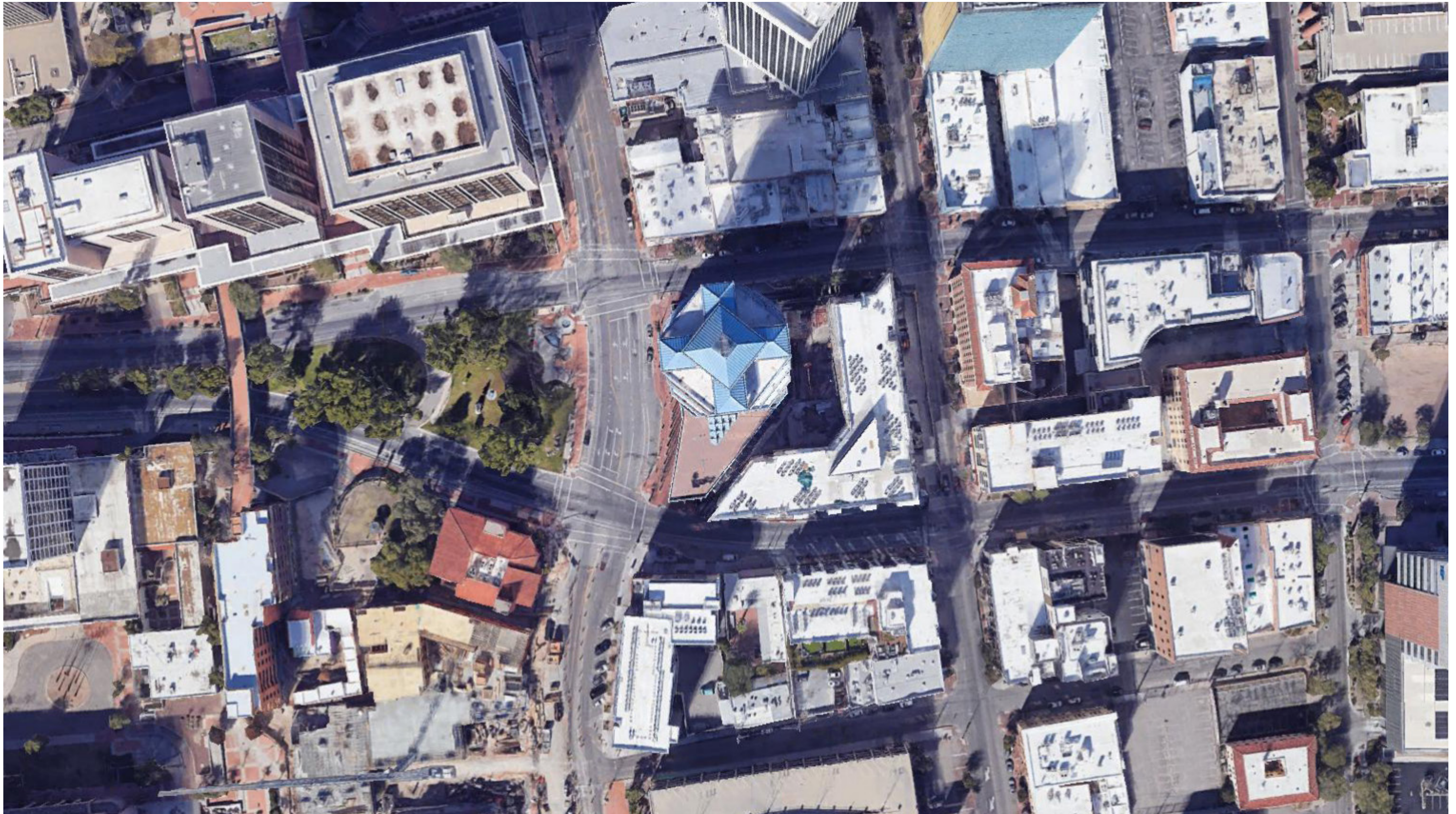

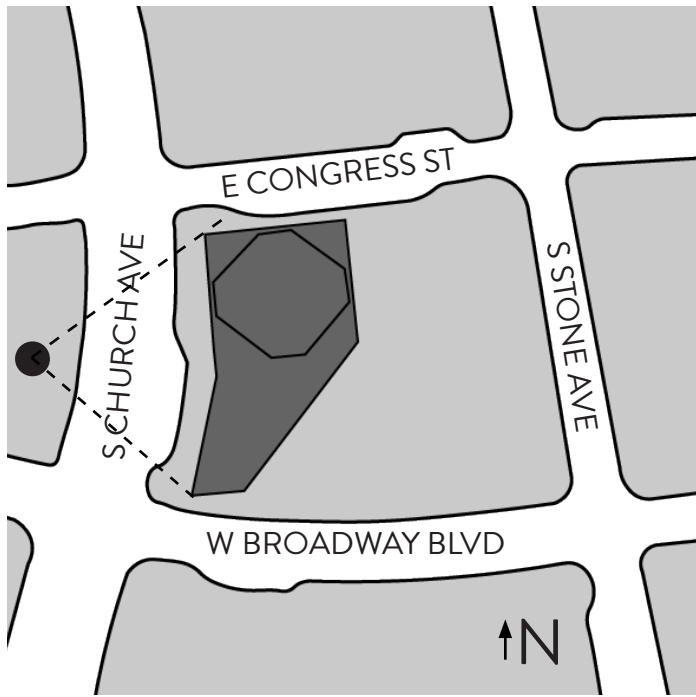
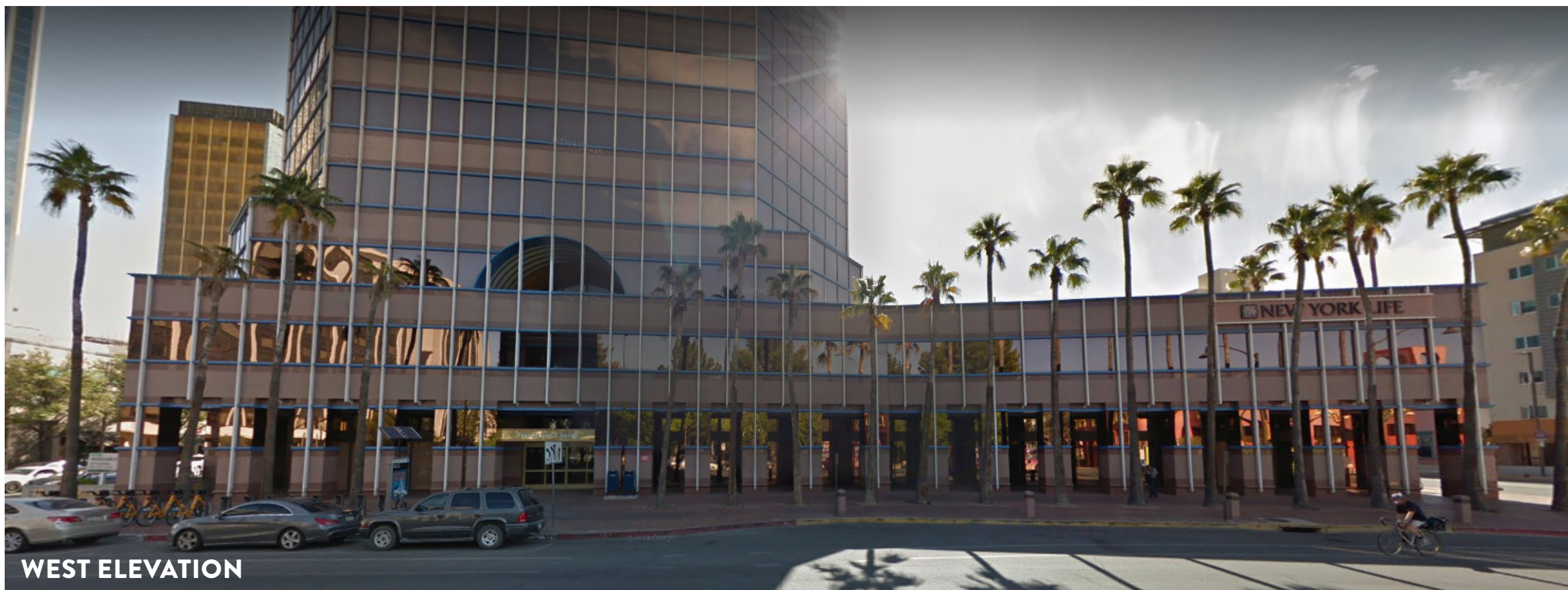



NORTH ELEVATION

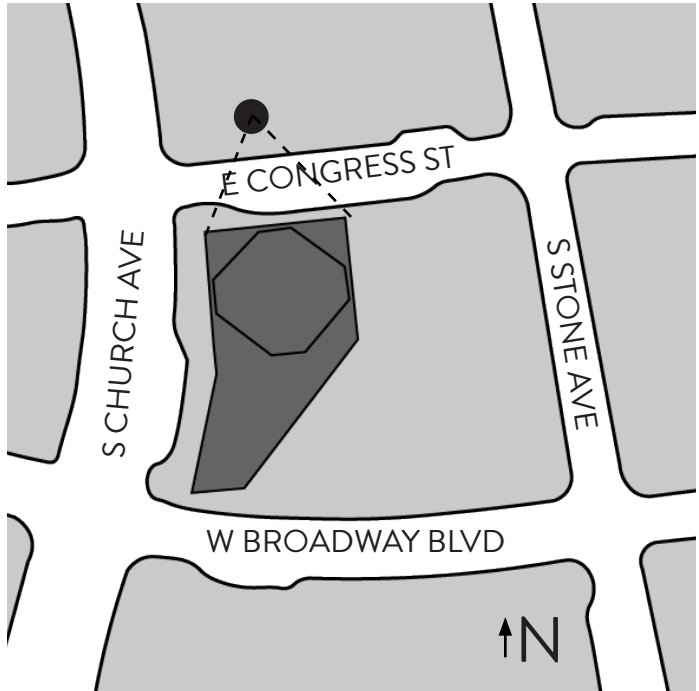



EAST ELEVATION

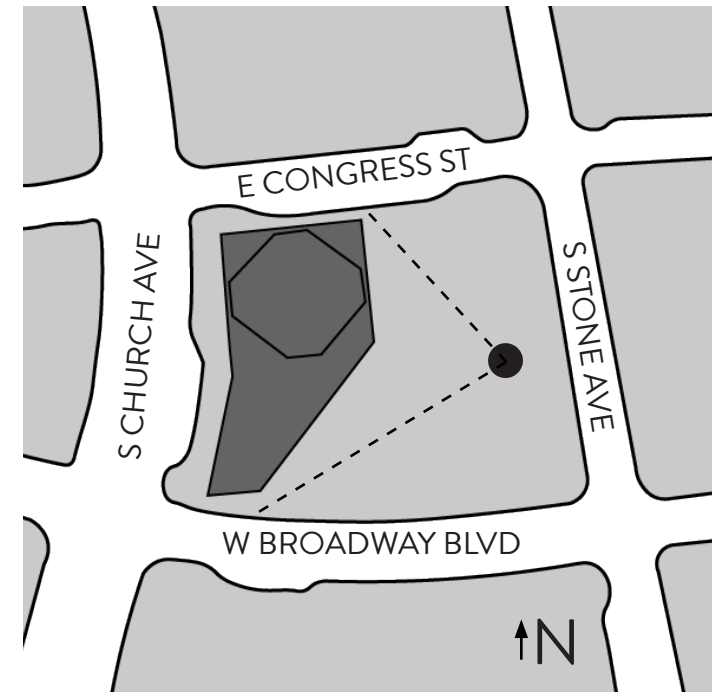



SOUTH ELEVATION

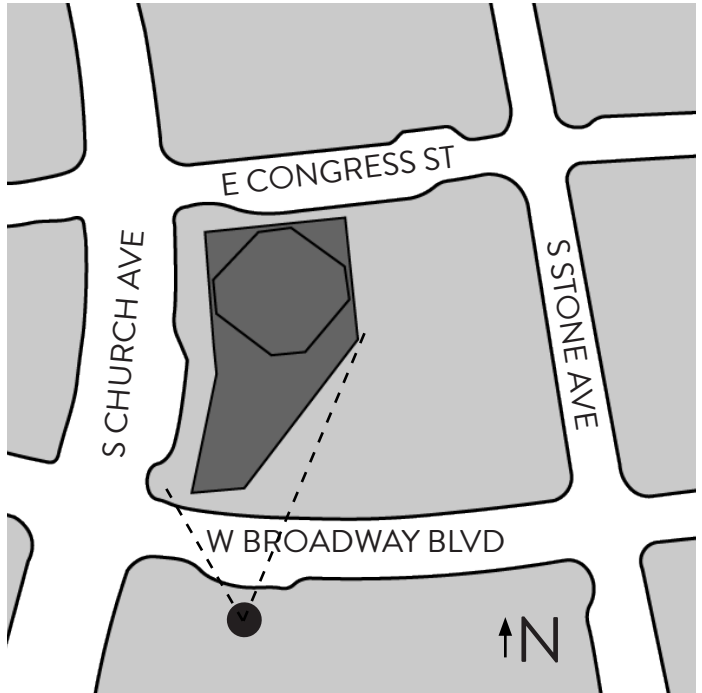



Parcel Number: 117-12-103C

Property Address			
Street Number	Street Direction	Street Name	Location
1	S	CHURCH AV	Tucson
24	W	CONGRESS ST	Tucson

Contact Information	
Property Owner Information: 1SC PARTNERS SPE LLC 6700 N ORACLE RD STE 504 TUCSON AZ 85704-7736	Property Description: TUCSON IRR PTNS OF LOTS 1 2 3 4 6 7 8 BLK 209 & PUEBLO CENTER REDEVELOPMENT PROJECT ARIZONA R-8 BLK 506 LOT 1 PTN LOT 2

Valuation Data							
Property Appraiser: Marianna Kuglmeier Phone: (520) 724-8159							
Valuation Year	Property Class	Assessment Ratio	Land FCV	Imp FCV	Total FCV	Limited Value	Limited Assessed
2021	COMMERCIAL (1)	18.0	\$792,692	\$20,207,308	\$21,000,000	\$21,000,000	\$3,780,000
2022	COMMERCIAL (1)	18.0	\$792,692	\$30,303,400	\$31,096,092	\$22,050,000	\$3,969,000

Property Information					
Township:	14.0	Section:	12 *	Range:	13.0E
Map:	3	Plat:	70	Block:	209
Tract:		Land Measure:	31,695.00F	Lot:	00004
Census Tract:	100	File Id:	1	Group Code:	
Use Code:	1524 (OFFICE BUILDING 4 STY PARKING NOT SEP PAR)			Date of Last Change:	2/4/2020

Sales Information (3)							
Affidavit of Fee No.	Parcel Count	Sale Date	Property Type	Sale	Time Adjusted Sale	Cash	Validation
20152750647	3	10/2015	Commercial/Industrial	\$32,000,000	\$32,000,000	N	W1 RJM
20020390541	3	2/2002	Commercial/Industrial	\$32,500,000	\$32,500,000	N	W1 JAC DEED: Special Warranty Deed
20002420529	3	12/2000	Commercial/Industrial	\$24,800,000	\$24,800,000	N	W1 JAC DEED: Special Warranty Deed

Valuation Area				
District Supervisor: ADELITA GRIJALVA District No: 5				
DOR Market	Land Subarea	Neighborhood	Sub ID	Economic District
31	1111044 DEL	08021001	03070 DEL	30

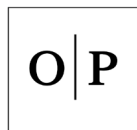

Recording Information (6)				
Sequence No.	Docket	Page	Date Recorded	Type
20203370329	0	0	12/2/2020	SCRIVE
20193250665	0	0	11/21/2019	QCDEED
20152750647	0	0	10/2/2015	WTDEED
20020390541	11745	2334	2/27/2002	WTDEED
20002420529	11446	2206	12/15/2000	
92154150	9399	999	10/19/1992	

Commercial Characteristics				
Commercial Summary				
Interface	Total Sq Ft	Cost Value	CCS Override	Market Override
Y	285,521	\$44,021,888	\$0	\$30,303,400

Commercial Detail							
SEQ-SECT	Const Year	Model / Grade	IPR	Sq Ft	RCN	RCNLD	Model Description
001-001	1986	151/3	0000000	285,521	\$56,846,393	\$40,667,910	BUSINESS OFFICE
003-001	1986	292/3	0000000	0	\$5,458,949	\$3,353,978	PARKING GARAGE BELOW GRADE



OPWEST PARTNERS

6900 E. Camelback Rd., Suite 902
Scottsdale, AZ 85251

OpwestPartners.com

TYLER A. KENT

Managing Director

602.672.9380

TK@OpwestPartners.com

NELSEN PARTNERS

15210 N. Scottsdale Rd., Suite 300
Scottsdale, AZ 85254

NelsenPartners.com

GEORGE A. MELARA, AIA

Vice President | Managing Director

480.949.6800

GMelara@NelsenPartners.com