

HILTON Dual Brand Hotel

141 SOUTH STONE AVENUE



Office Building

123 S. Stone Ave.

Historic Contributing Property



Scottish Rite Cathedral

160 S. Scott Ave.

Historic Contributing Property



La Placita

Parking Garage

211 S. Church Ave.

Noncontributing Property

Cathedral Square

Conference & Education Center

192 S. Stone Ave.

Noncontributing Property

St. Augustine Cathedral

192 S. Stone Ave.

Nat. Register of Historic Places



Blenman House

204 S. Scott Ave.

Historic Contributing Property



Banovitz House

21 E. Corral St.

Historic Contributing Property

Diocese Building

192 S. Stone Ave.

Noncontributing Property

Residential Condominiums

201 S. Stone Ave.

Noncontributing Property

HILTON Dual Brand Hotel

141 SOUTH STONE AVENUE

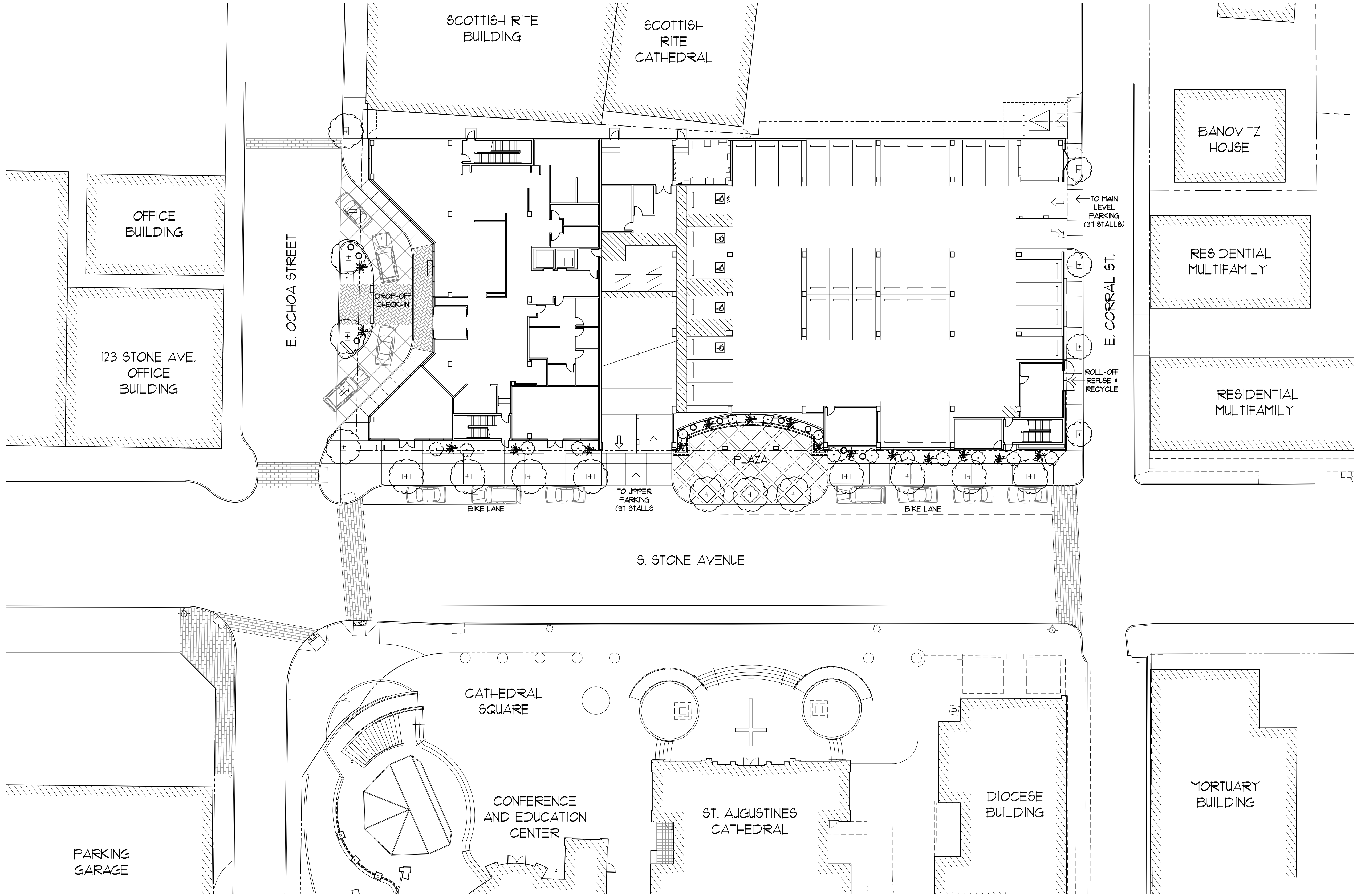

SITE PLAN

June 28, 2019

NORTH

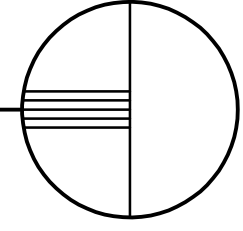

HILTON Dual Brand Hotel

141 SOUTH STONE AVENUE

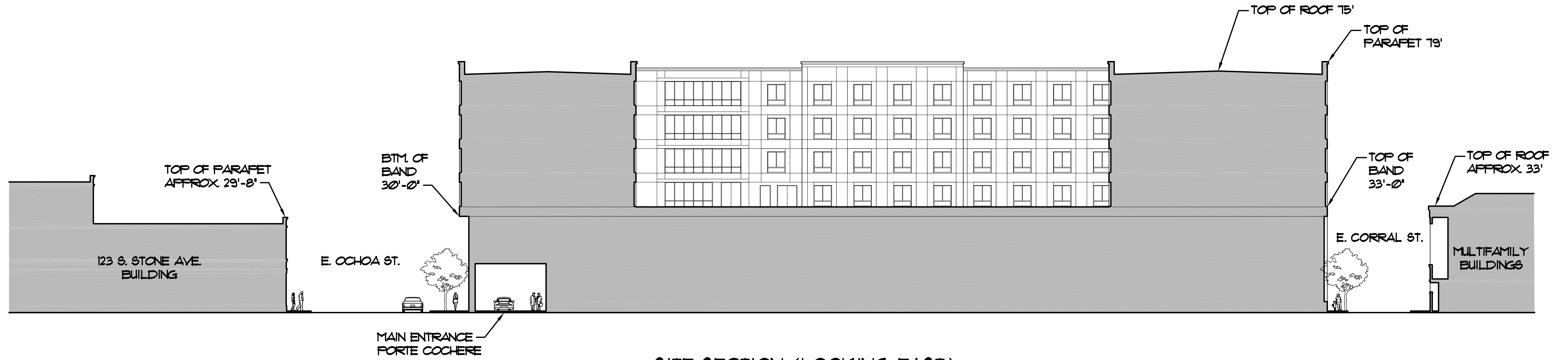

SITE SECTION (LOOKING EAST)

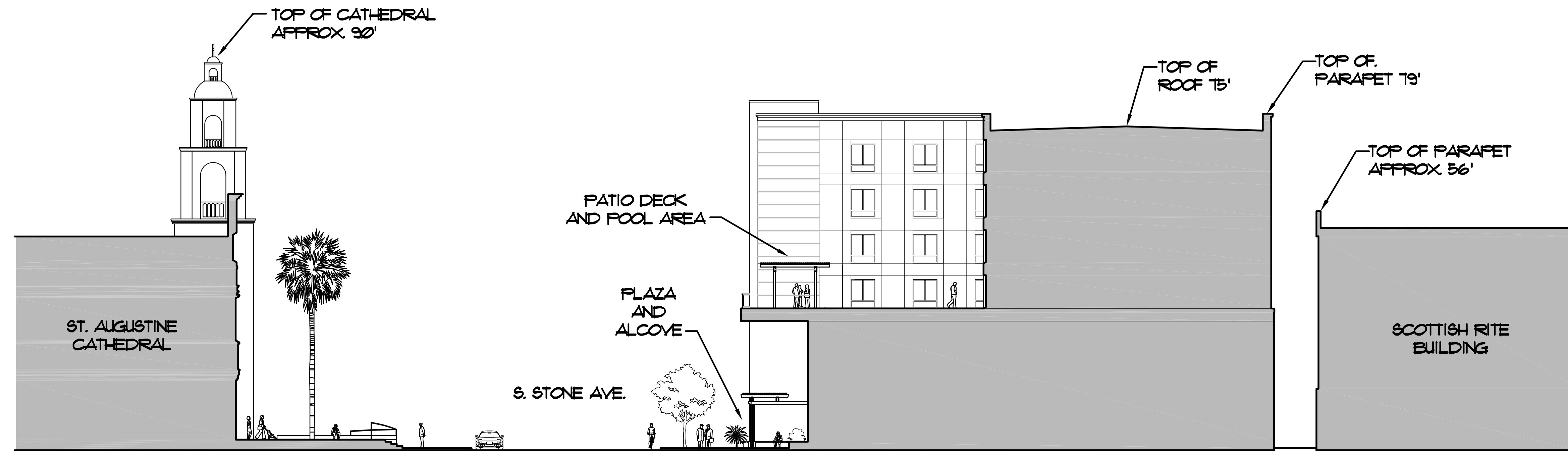

SITE SECTION (LOOKING NORTH)

HILTON Dual Brand Hotel

141 SOUTH STONE AVENUE

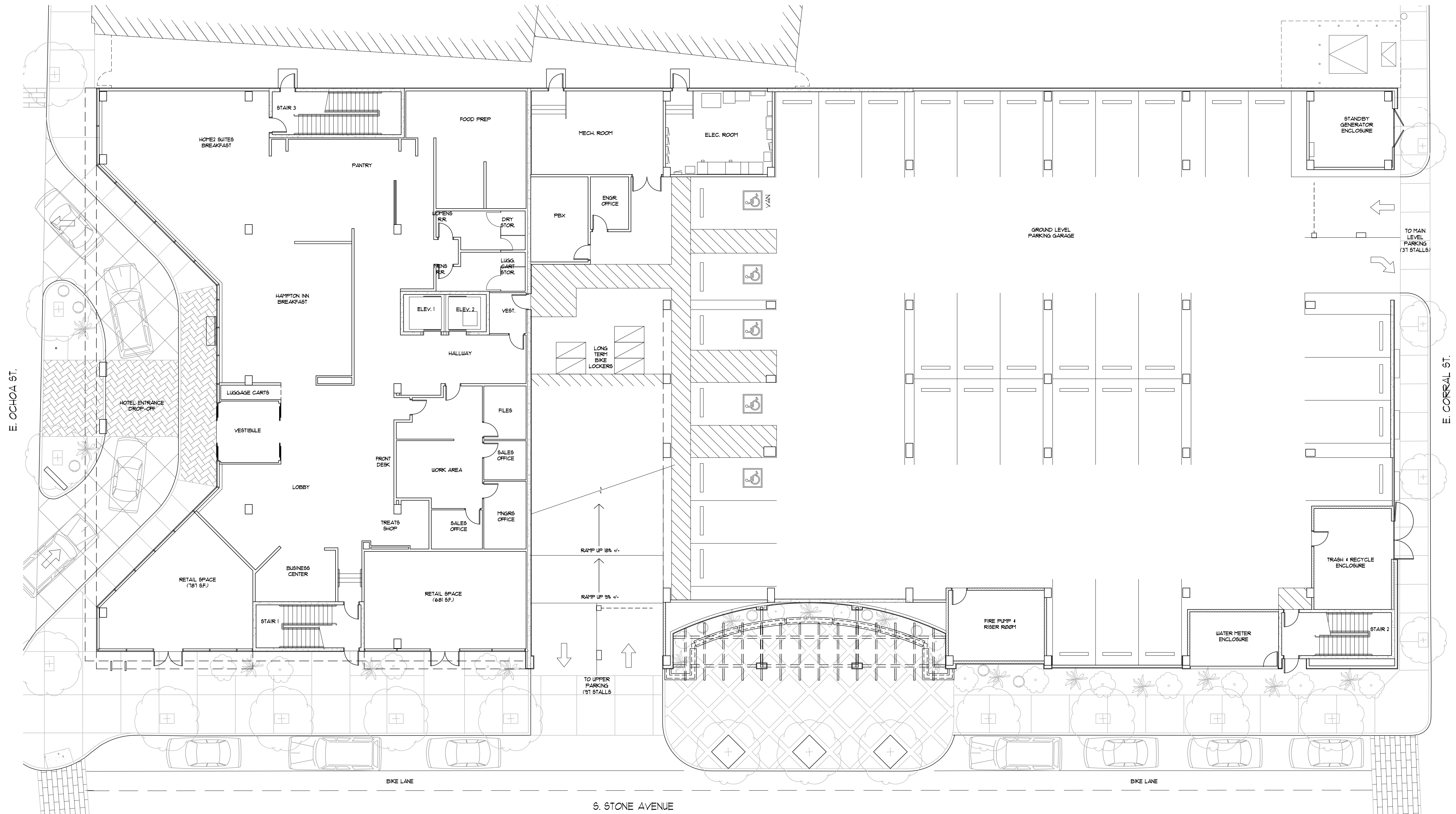

FLOOR PLAN - 1st LEVEL GARAGE

June 28, 2019

HILTON Dual Brand Hotel

141 SOUTH STONE AVENUE

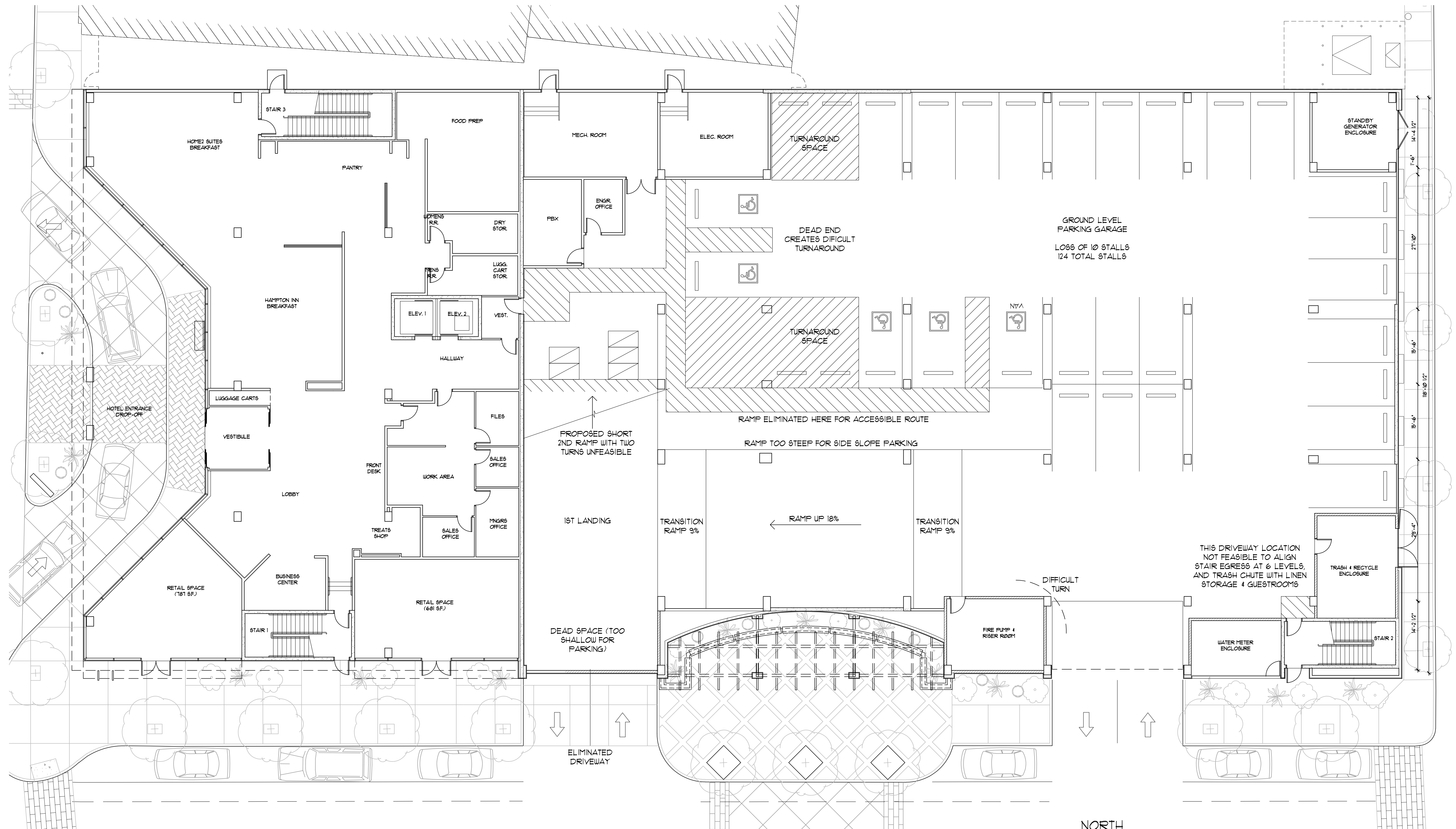

FLOOR PLAN - 1st LEVEL GARAGE - ALTERNATE STUDY

June 28, 2019

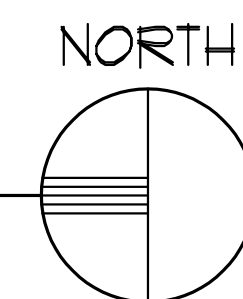

HILTON Dual Brand Hotel

141 SOUTH STONE AVENUE

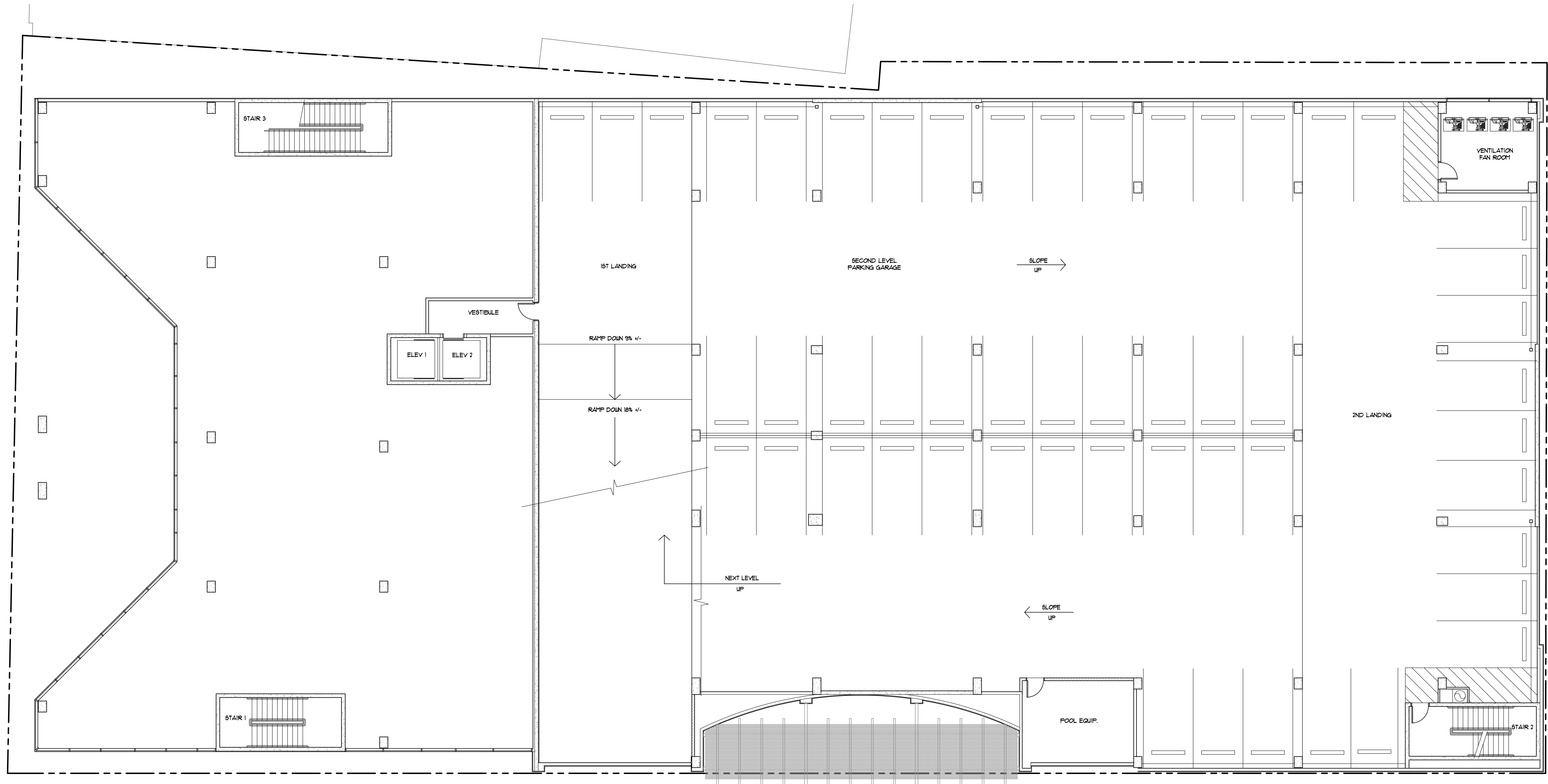

FLOOR PLAN - 2nd LEVEL GARAGE

June 5, 2019

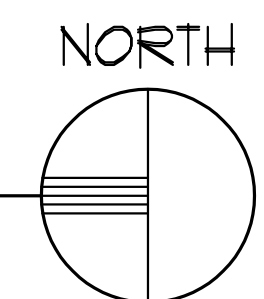

HILTON Dual Brand Hotel

141 SOUTH STONE AVENUE

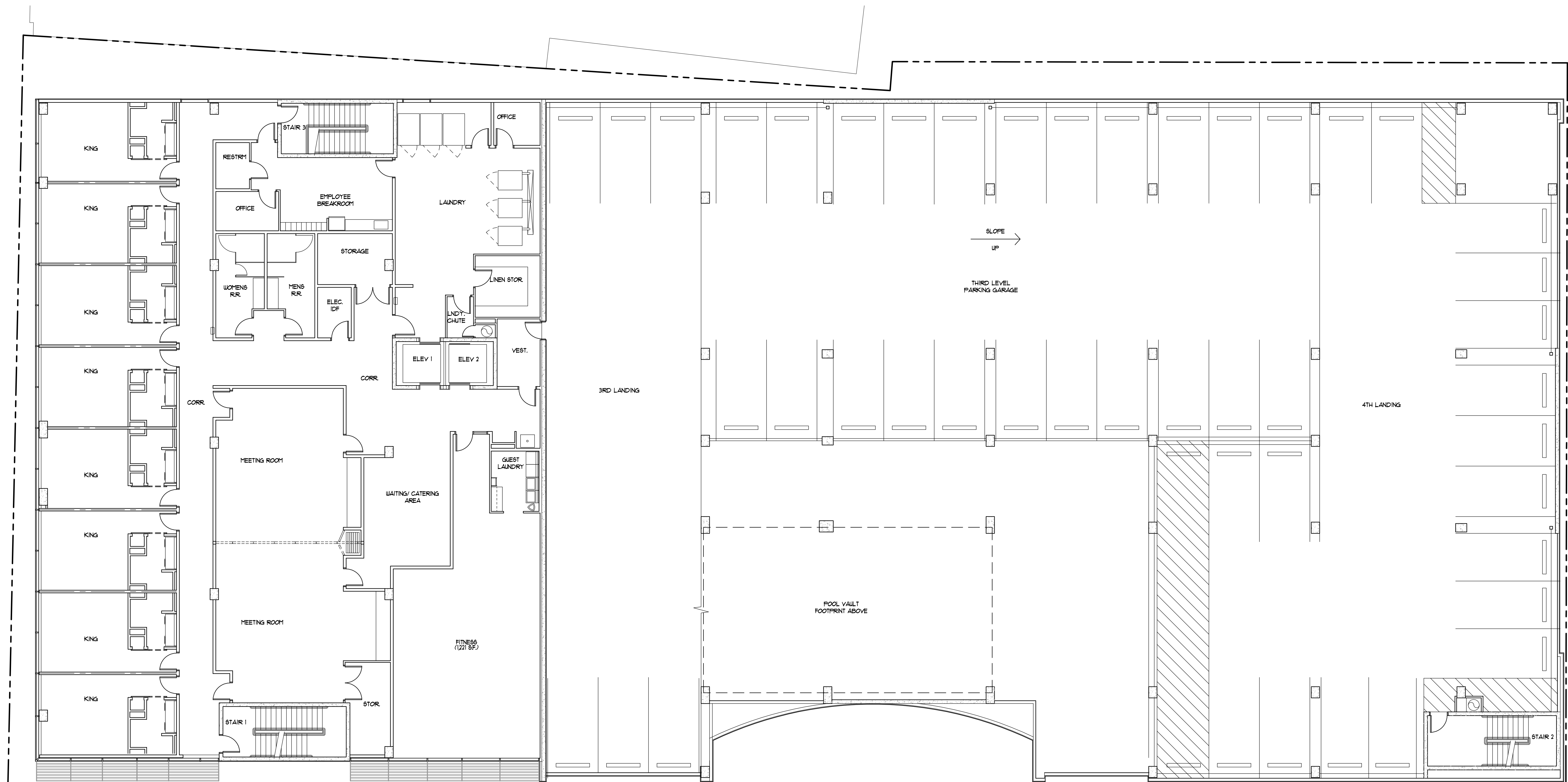

FLOOR PLAN - 3rd LEVEL GARAGE

June 5, 2019

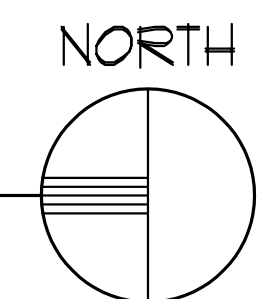

HILTON Dual Brand Hotel

141 SOUTH STONE AVENUE

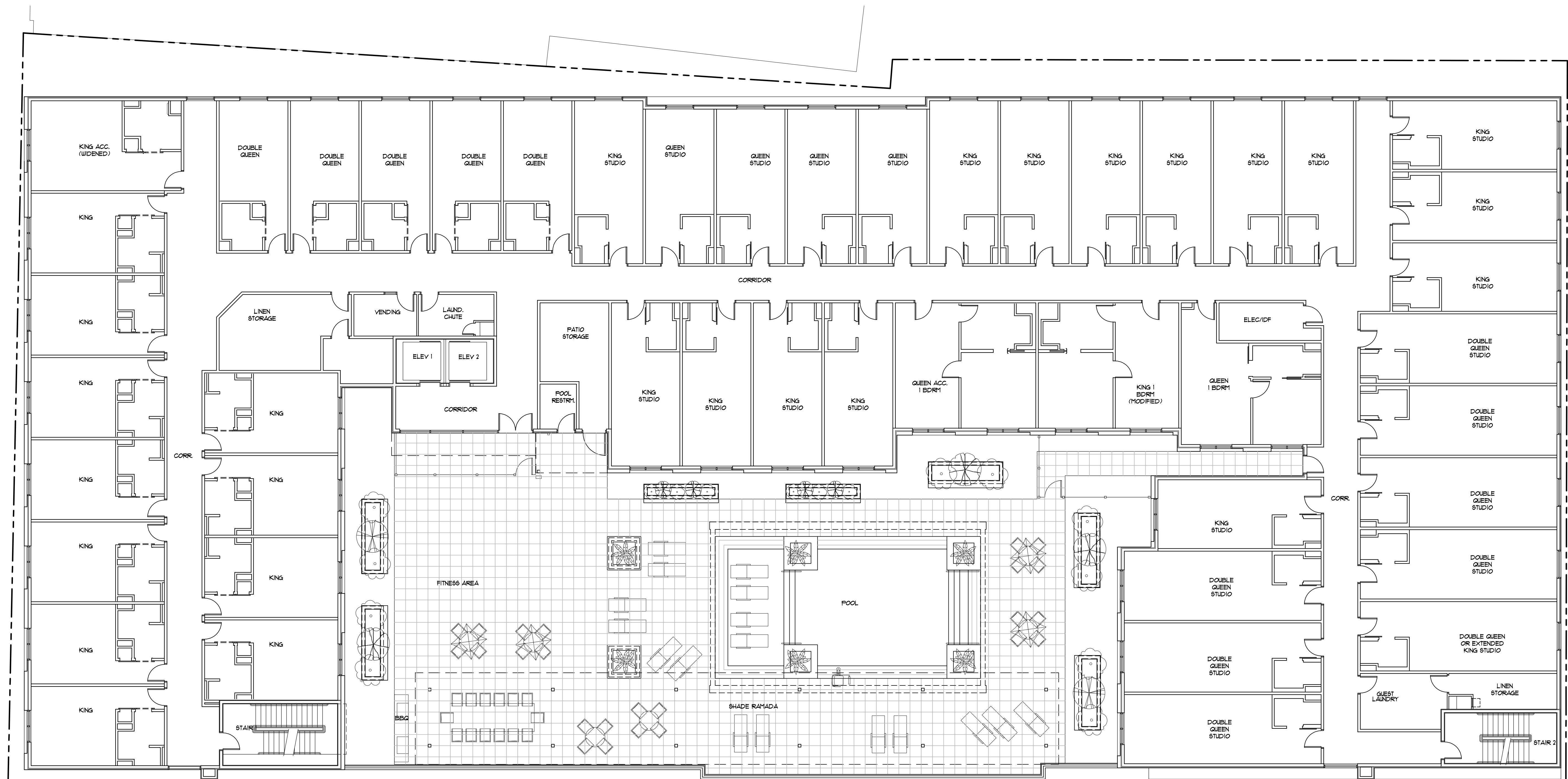

FLOOR PLAN - 3rd LEVEL HOTEL

June 5, 2019

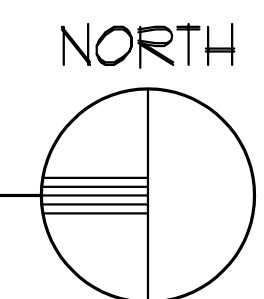

HILTON Dual Brand Hotel

141 SOUTH STONE AVENUE



NORTH ELEVATION (FACING E. OCHOA ST.)

SCALE: 1/20" = 1'-0"

June 28, 2019

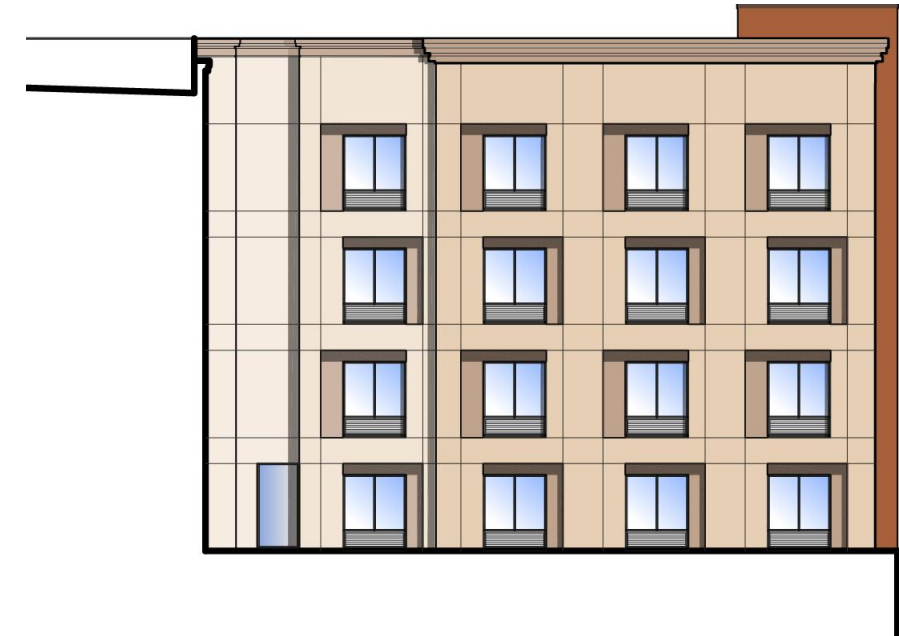

NORTH ELEVATION (INSIDE POOL/PATIO AREA)

SCALE: 1/20" = 1'-0"

HILTON Dual Brand Hotel

141 SOUTH STONE AVENUE



WEST ELEVATION (FACING S. STONE AVE.)

SCALE: 1/20" = 1'-0"

June 28, 2019

HILTON Dual Brand Hotel

141 SOUTH STONE AVENUE



SOUTH ELEVATION (FACING E. CORRAL ST.)

SCALE: 1/20" = 1'-0"

June 28, 2019



SOUTH ELEVATION (INSIDE POOL/PATIO AREA)

SCALE: 1/20" = 1'-0"

HILTON Dual Brand Hotel

141 SOUTH STONE AVENUE



EAST ELEVATION (FACING SCOTTISH RITE PROP.)

SCALE: 1/20" = 1'-0"

June 28, 2019

HILTON Dual Brand Hotel

141 SOUTH STONE AVENUE



PERSPECTIVE FROM NORTHWEST

June 28, 2019

HILTON Dual Brand Hotel

141 SOUTH STONE AVENUE



HILTON Dual Brand Hotel

141 SOUTH STONE AVENUE



HILTON Dual Brand Hotel

141 SOUTH STONE AVENUE



PERSPECTIVE AERIAL FROM WEST

June 28, 2019

HILTON Dual Brand Hotel

141 SOUTH STONE AVENUE



PERSPECTIVE FROM WEST

June 28, 2019

HILTON Dual Brand Hotel

141 SOUTH STONE AVENUE



HILTON Dual Brand Hotel

141 SOUTH STONE AVENUE



HILTON Dual Brand Hotel

141 SOUTH STONE AVENUE



HILTON Dual Brand Hotel

141 SOUTH STONE AVENUE



ELEVATION LOOKING SOUTH

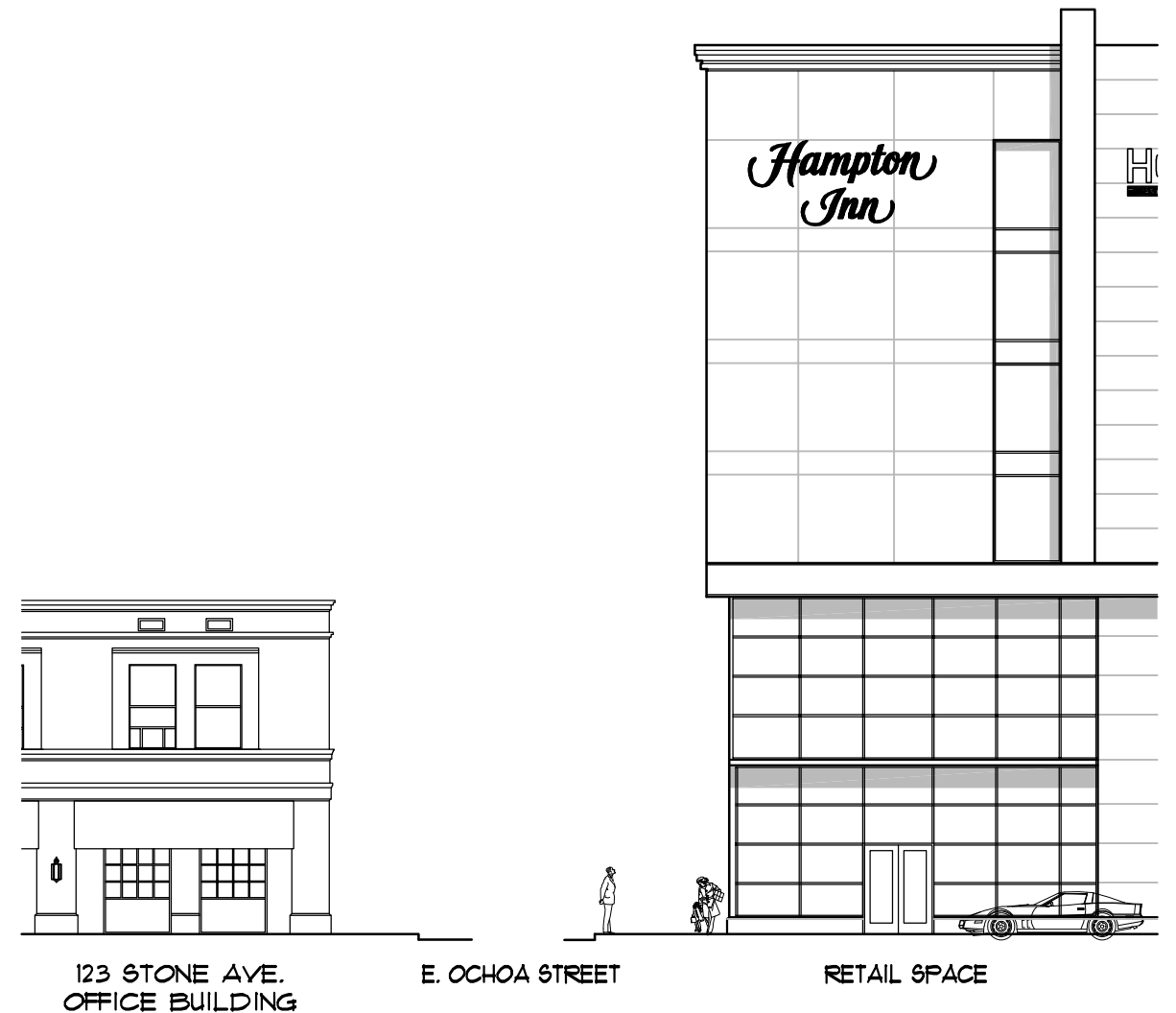

ELEVATION LOOKING EAST

HILTON Dual Brand Hotel

141 SOUTH STONE AVENUE

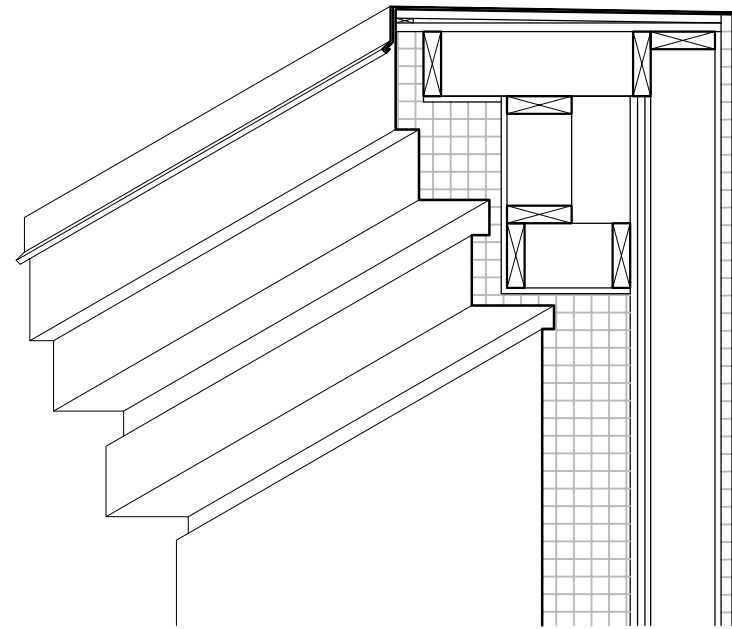

PRIMARY CORNICE

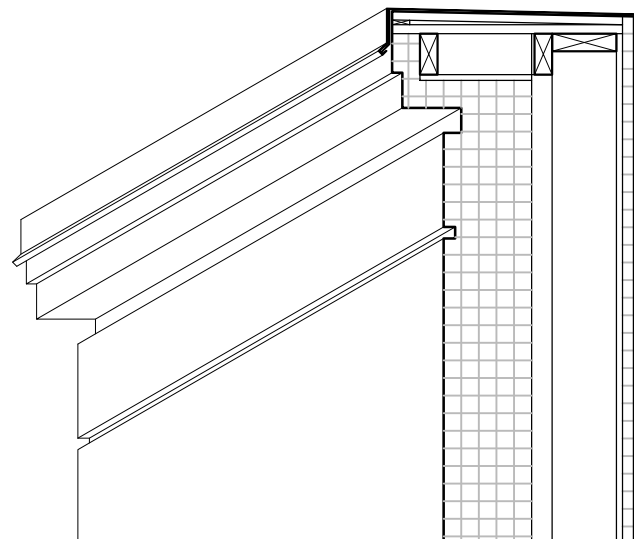
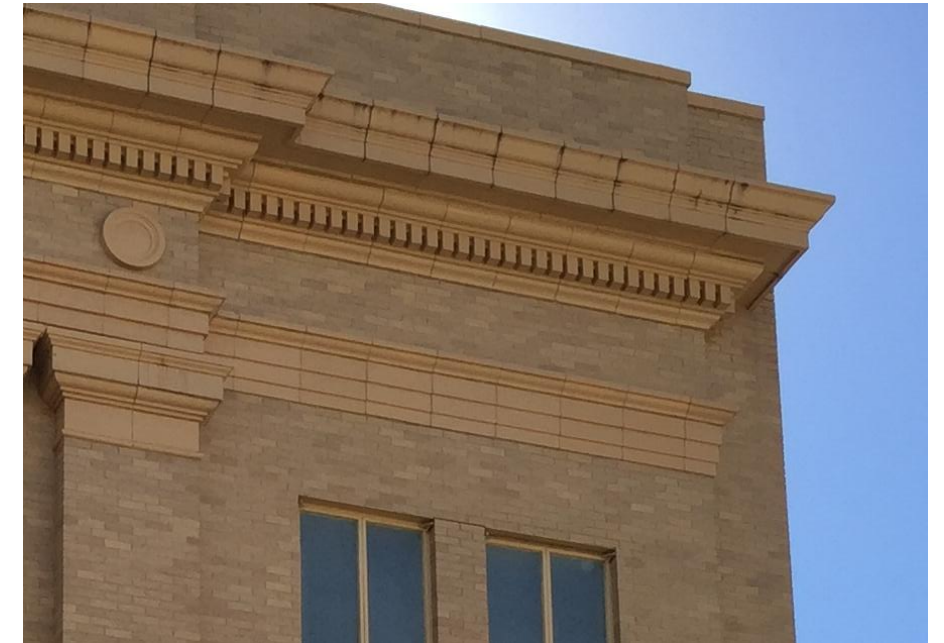

SECONDARY CORNICE



HILTON Dual Brand Hotel

141 SOUTH STONE AVENUE

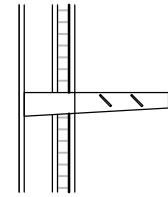

SHADE LOUVERS

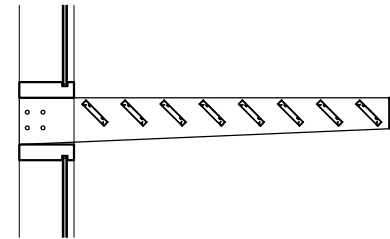

LOUVERED SHADE CANOPY

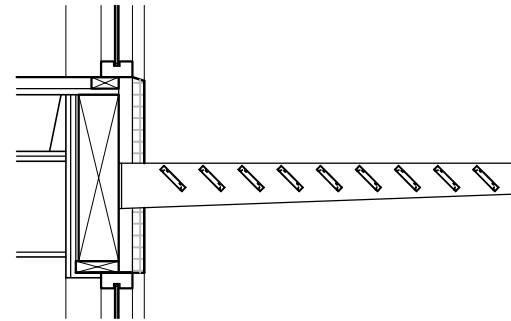

LOUVERED SHADE CANOPY

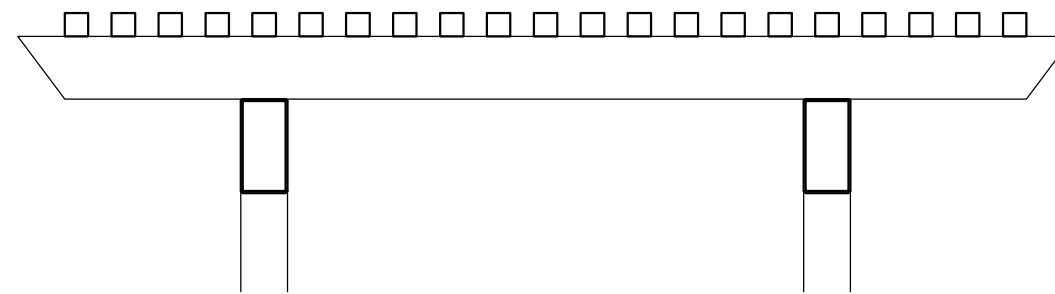

SHADE TRELLIS



HILTON Dual Brand Hotel

141 SOUTH STONE AVENUE

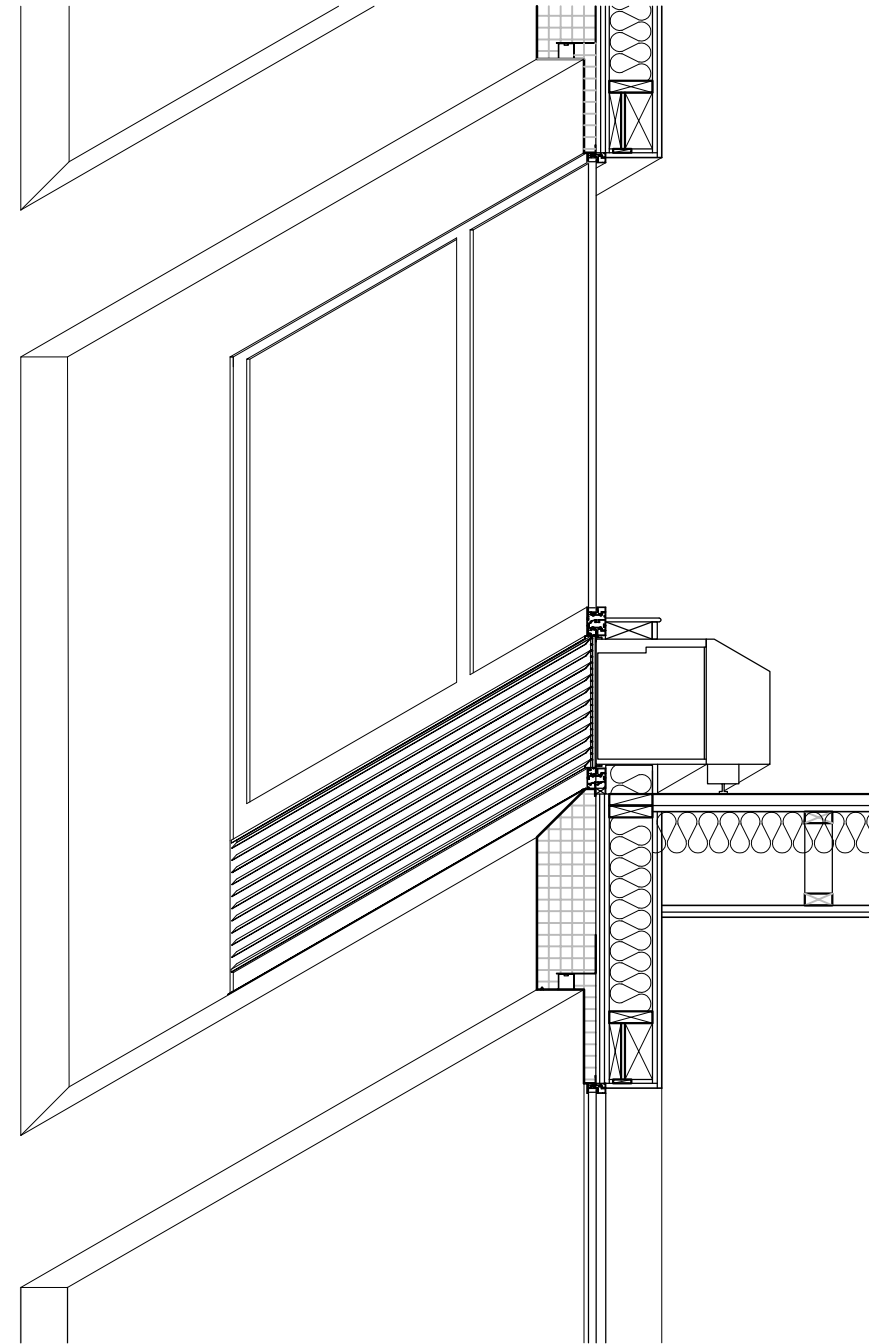

WINDOW SHADOW BOX

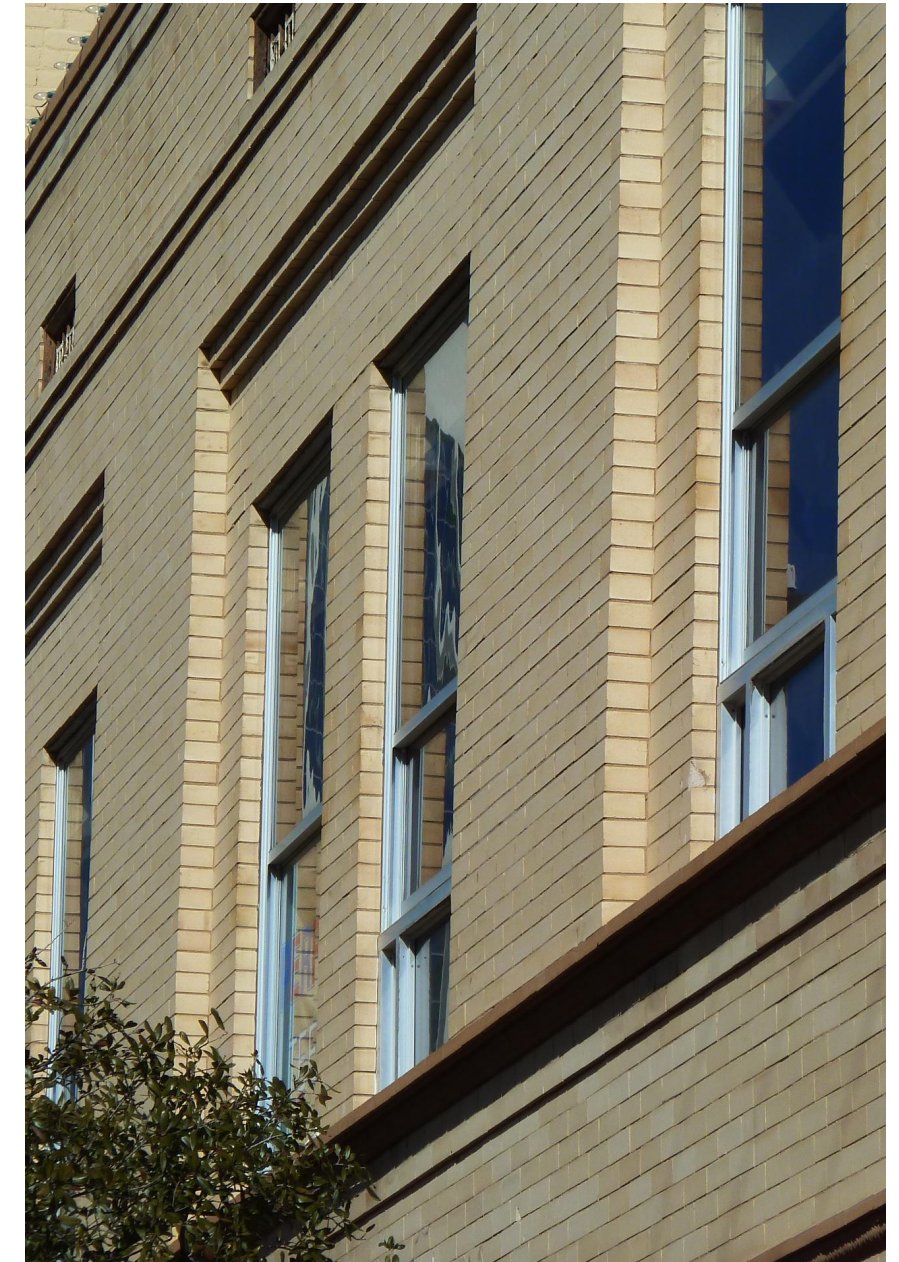

HILTON Dual Brand Hotel

141 SOUTH STONE AVENUE

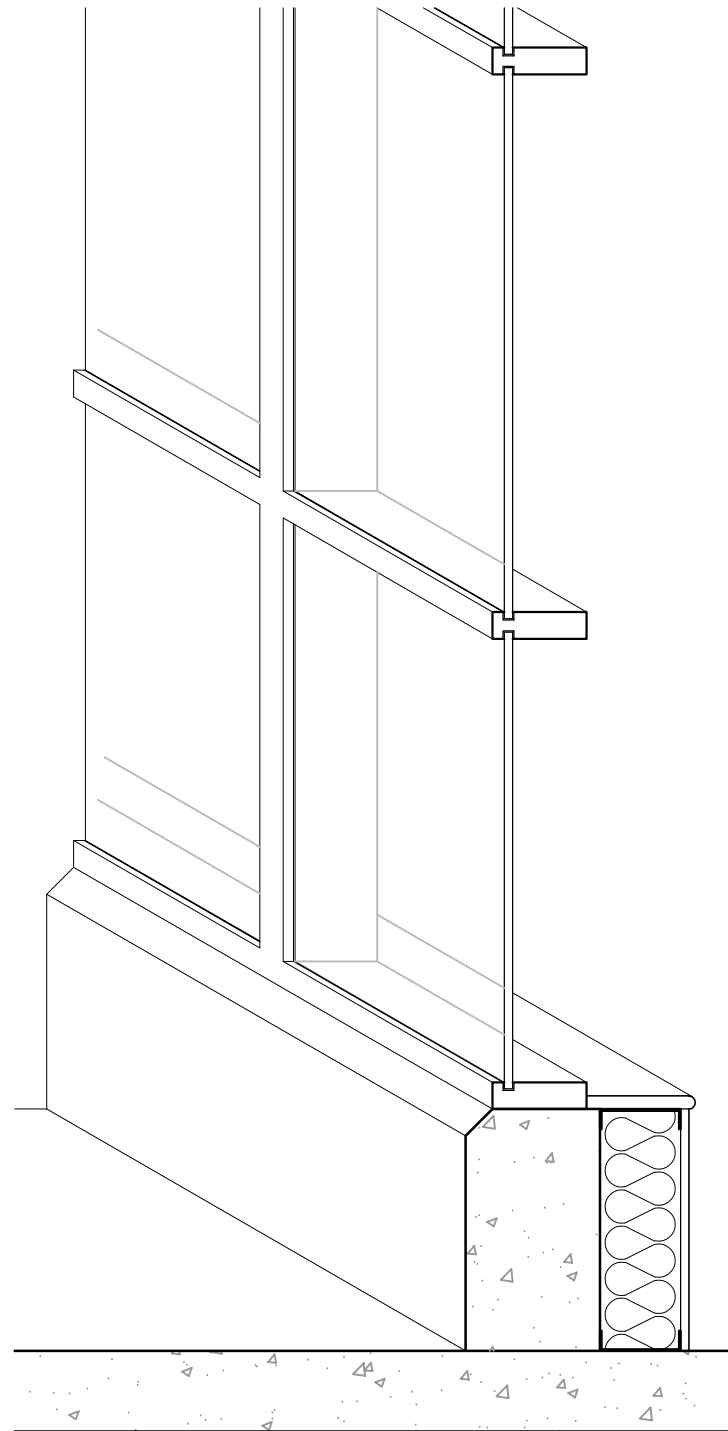

WALL AND COLUMN BASE

HILTON Dual Brand Hotel

141 SOUTH STONE AVENUE



**Color of
St. Augustine Cathedral**

Building Color Palette

SW 6356
Copper Mountain

SW 6354
Armagnac

SW 6094
Sensational Sand

SW 6113
Interactive Cream

SW 0035
Indian White

SW 6074
Spalding Gray

SW 7020
Black Fox

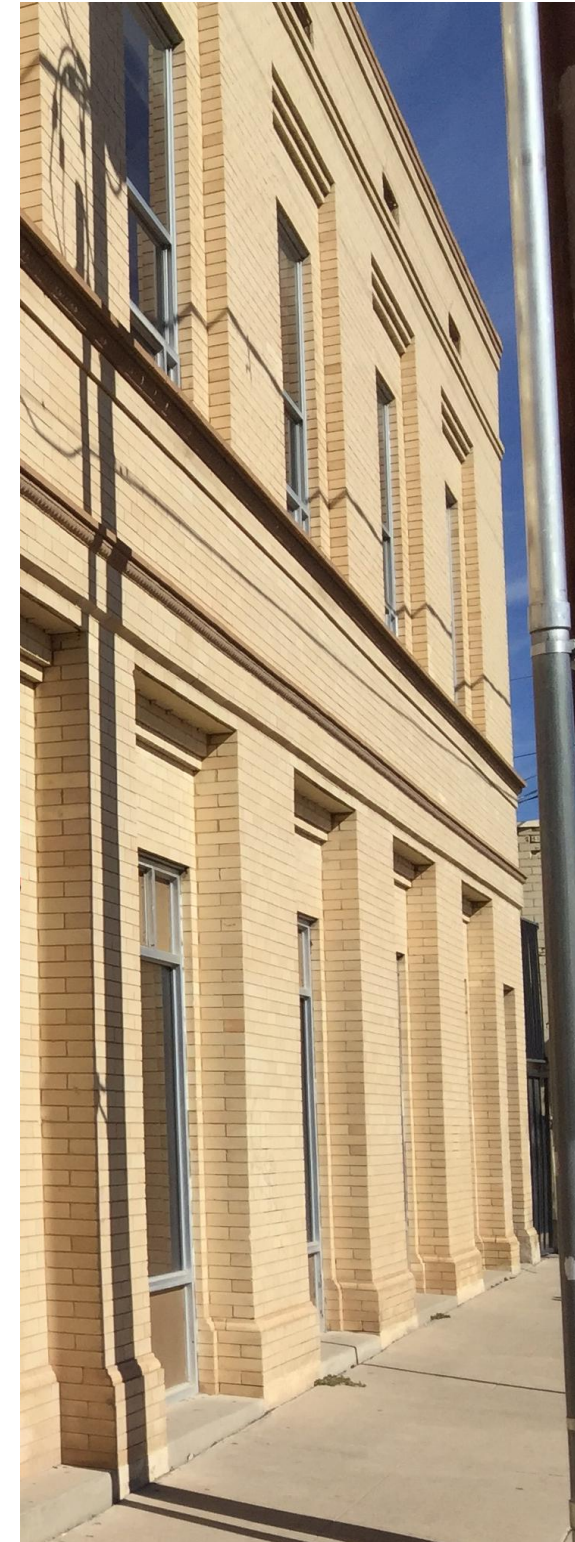

**Color of
123 S. Stone Ave.**

HILTON Dual Brand Hotel

141 SOUTH STONE AVENUE



**Stencil Pattern at
St. Augustine Cathedral**



**Plaza Alcove
Stencil Pattern Concept
(style and color to be
determined)**

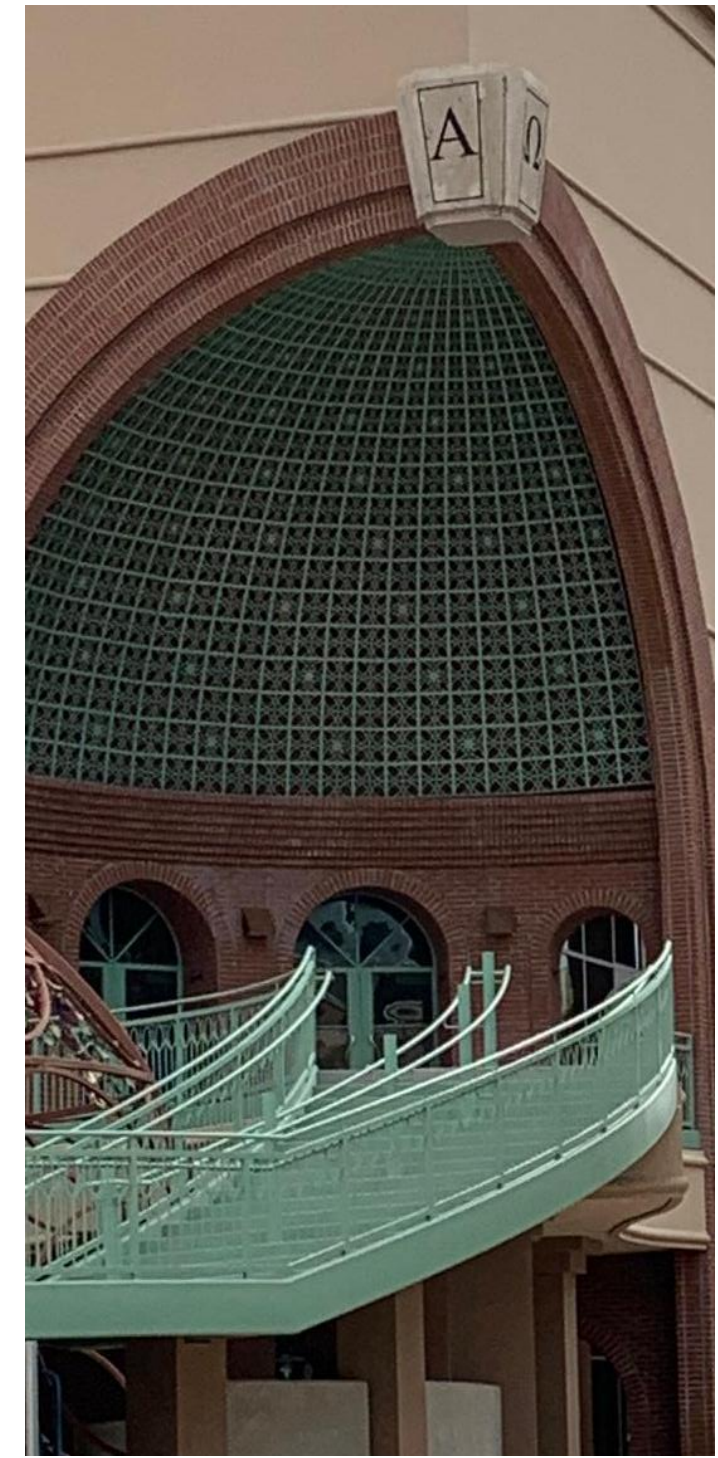

**Mosaic Pattern at
Cathedral Square**

HILTON Dual Brand Hotel

141 SOUTH STONE AVENUE



Quercus buckleyi
Red Rock Oak



Russelia equisetiformis
Firecracker Bush



Euonymus japonicus 'Microphyllus'
Boxleaf Euonymus



Agave desmettiana
Smooth Agave



Euphorbia antisiphilitica
Candelilla



Lophocereus schottii monstrosus
Totem Pole Cactus



Pedilanthus macrocarpus
Slipper Plant



Aloe barbadensis
Aloe



Nassella tenuissima
Mexican Feather Grass



MacFadyena unguis-cati
Cat Claw Vine



Campsis Radicans
Trumpet Creeper



Lantana x 'New Gold'
New Gold Lantana



Lantana montevidensis
Trailing Lantana



Gaillardia x grandiflora 'Arizona Sun'
Arizona Sun Blanket Flower



Dietes iridioides
Butterfly Iris