

Submission to West University Historic Review Board

For: June 2022 meeting

Re: Studio/Carport Building Proposal

Property: 721 N 3RD Ave, Tucson, AZ, 85705

Home Owner: David and Susan Weinman (DSW Properties III)

Contractor: Mark O'Hagin

Resident and designated agent: Peter Weinman

In this document:

- (1) Scope of project, referencing 5.8.9 Design Standards
- (2) Plot plan showing proposed new building
- (3) Elevation views of proposed new building with window descriptions
- (4) Photos showing surrounding area and placement of new building
- (5) Development zone
- (6) Copy of building plans submitted to planning
- (7) Elevation views of main house on property
- (8) Historic property inventory of 1979
- (9) Initial Historic Review application, March 2022
- (10) Zoning review notes regarding setbacks

(1) Scope of Project

We would like to build at the rear of the property a small studio/storage room with an attached covered area for parking two cars.

General Notes

The back portion of the property is currently an open dirt space for parking. It is surrounded by a 6ft tall stucco block wall, with commercial property surrounding it. With it being almost impossible to see from any view, the impact on the neighborhood is expected to be minimal.

Specific reflections on the 5.8.9 Design Standards regarding this project:

A. Generally: The proposed building is not replacing or changing any existing structure. The proposed building is a simple small rectangular building, looking like an insignificant out building that is common at the rear of many long and narrow historic plots.

B. Height: The highest point is 11.4ft. With the slope of the property, it will actually feel lower than 11.4ft, which is as low or lower than all buildings in the development zone, contributing or not contributing. Heights of contributing buildings in our development zone and surrounding area are approximately:

Main house, 721 N 3rd Ave, is 18ft 10in

Two-story brick building directly south, 723 N 3rd Ave: 20ft.

Large two-story house to the south, 445 E. 4th St: 26ft.

730 N. 3rd Ave: 17ft.

722 N. 3rd Ave: 19ft. (Out building of 12ft)

502 E. University: 22ft.

503 E. University: 20ft.

519 E. University: 19ft. (Out building of 13ft)

728 N. Bean: 11ft, 21ft, 10ft

777 N. Bean: 11ft

518 E. University: 17

516 E. University: 17

512 E. University: 24ft

501 E. 4th St.: 24ft

Time Market, to the north: 21ft.

C. Setbacks: We are asking for a **3ft set back on the north side and a 1ft set back on the south side.** (There is a 23ft set back to the west property line.) We request this for two reasons:

First, we need the space. Our property narrows greatly towards the west ever since 723 N. Third Ave was carved out of the original strap to become its own property a number of years ago. To get a building large enough to be usable, and also build to allow two cars under cover, we need the short setbacks. There is NO parking allowance for our cars immediately in front of the house anywhere on 3rd Ave, ever since metered parking was installed a few years ago. This back of property space is the only place to park our cars. (We access through the church property through a gate on our west property wall.)

Second, it appears that 7 out of 9 main residential buildings in our immediate development zone have less than 6ft setbacks on at least one side, making smaller setbacks actually “more normal” than exceptional.

The adjacent building to the south, 723 N 3rd Ave, sits on its property line to the south and is approximately 4ft from its property line to the north. (We also own this building, and of course have no problem with a close setback.)

The historic guest house as part of the property of 445 E. 4th street also sits on its property line to the north (our 721 N 3rd property line on the south).

502 E. University sits very close to its property line to the east.

722 N. 3rd Ave and 730 N. 3rd Ave both are very close to their property lines on their north sides.

501 E. 4th St is very close to its east property line.

Furthermore, three out buildings in our development zone also have what looks to be as far less than 6ft setbacks.



722 N 3rd building at back of property



501 E 4th Ave building at back of property



502 E. University building at back of property

We understand that historic review authority can instruct planning to allow for our proposed setbacks. We are requesting this.

D. Proportion: The small size of the proposed building keeps it from competing in any significant way with the large house.

E. Roof Types: To keep overall height low, a low sloping metal roof is used. This will compliment the basic flat roof historic building immediately to the south, 723 N 3rd Ave. The roofs on both are, basically, not seen from any public space.

F. Surface Texture: The stucco finish will be a smooth finish, not trying to match the look of the historic home, but only compliment it.

G. Site Utilization: Because of the long and narrow configuration of these historic lots, it was very common to have small utility buildings built in the far back. That is all that this proposal is. Built, of course, with modern needs of better insulation and energy efficiency.

H. Projections and Recessions: There are no significant overhangs or awnings planned, and the few windows are chosen to fit well with a historic double hung sash window look.

I. Details: There are no known details that should be incorporated into this simple design, but the owner is open to suggestions. Windows will have bars on them to match the treatment on the main house. The thought is to keep the look clean and simple.

J. Building Form: The small size of this project should create no concerns here.

K. Rhythm: Again, the small size of this building does not make a strong statement out of sync with the rest of the property.

L. Additional Review Standards: Color – The plan is to match the color of the main house, off white with a faded blue trim. Landscaping – There is not much that can be done, but the building will sit nicely on the edge of the landscaped back yard of the main house, leaving a large garden area between the house and this building. Enclosures – There will be nothing more than a few low wooden fences, as have been there for some time, separating the back yard from the parking area. Utilities – The utility lines will be brought in underground.

M. Signs: No signs will be used.

N. Parking: As noted before, there is NO parking provided by the city directly in front of the main house, so this area is the only place for parking.

(2) Plot pan showing proposed new building

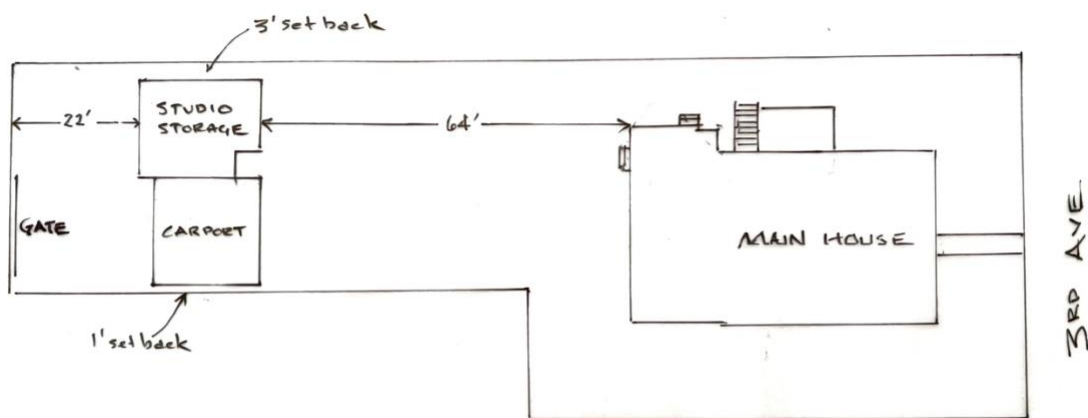

(3) Elevations of proposed new buildings

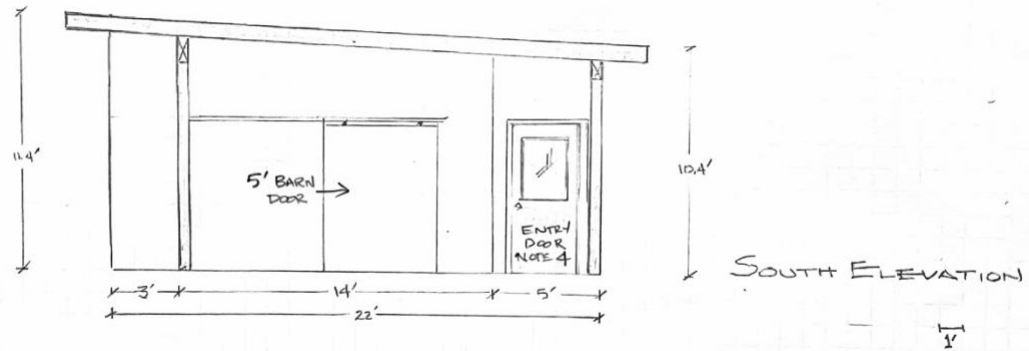
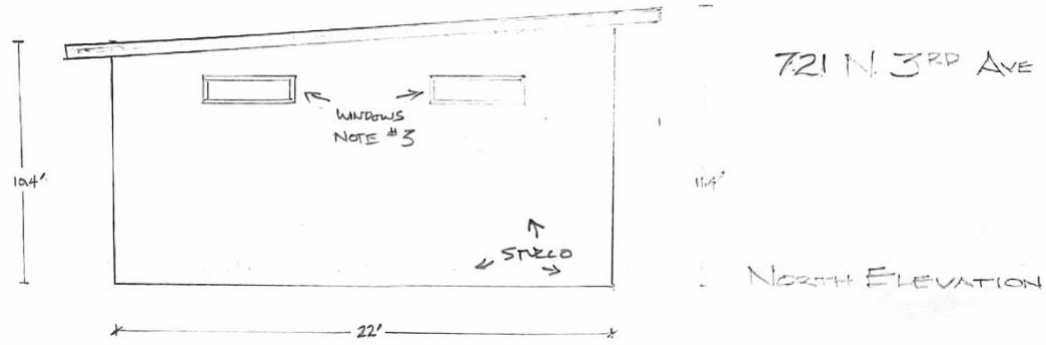

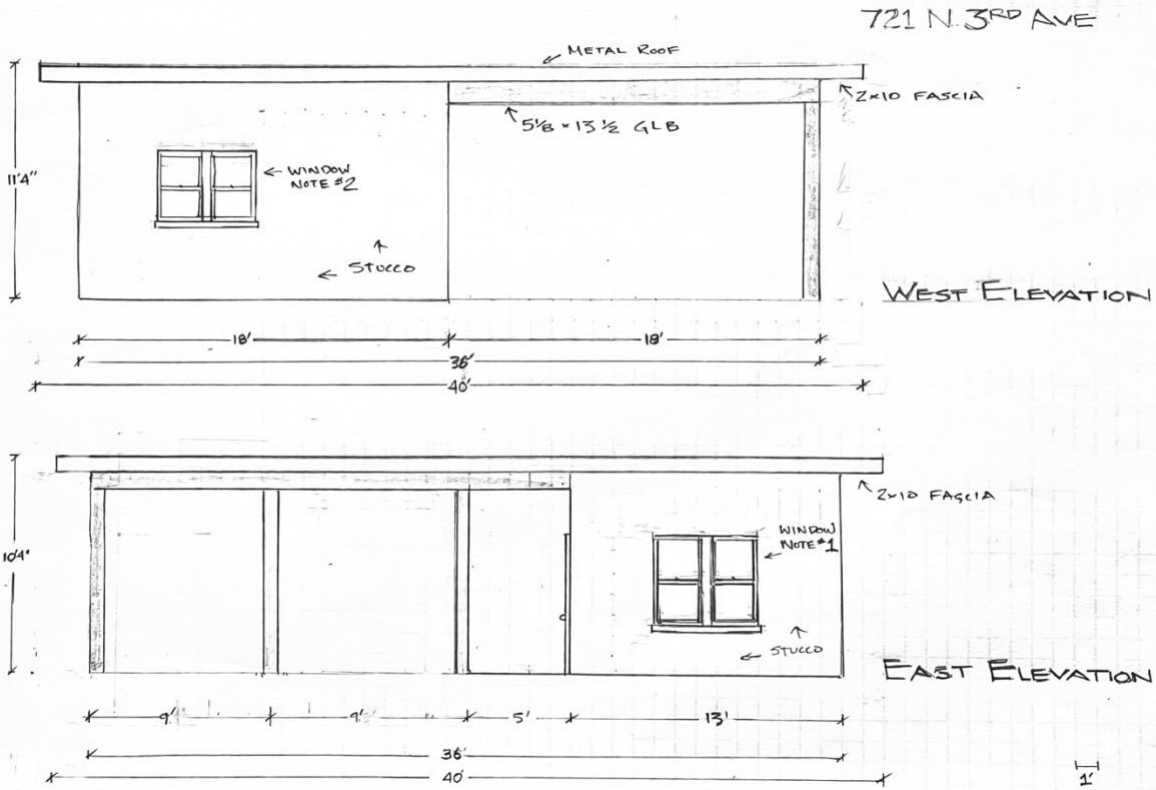

Window Notes: We plan to use Jeld-Wen double hung wood-clad windows. (Three lines to choose from, Sitrine, W-5500, W-2500.)

Note #1 Two windows, each window 28" wide, 4' tall. Side by side with divider between.

Note #2 Two windows, each window 24" wide, 3' tall. Side by side with divider between.

Doors: Note #4 Wooden door with glass panel. (Will have security screen door to match front house.) Barn Door will be a solid wood, tongue and groove door.

Post Caps and Bases: All post caps and bases will be approved specifications for current building requirements, but they will be painted/covered in a way to disguise their unattractive and non-historic look.

(4)Photos



View from north side of adjacent property, facing south. Proposed building will be behind this wall.



View from adjacent property to the south, facing north. Proposed building will be on other side of this wall, but the property drops down extensively behind this wall.



View from church property to the west, looking east. Proposed building is behind this wall.



Again, view from church property looking east. Proposed building is behind this wall.



View to main house facing east. Standing on spot of proposed building.



View facing north, looking at building site



Aerial photo showing location of proposed building. (Google Earth)

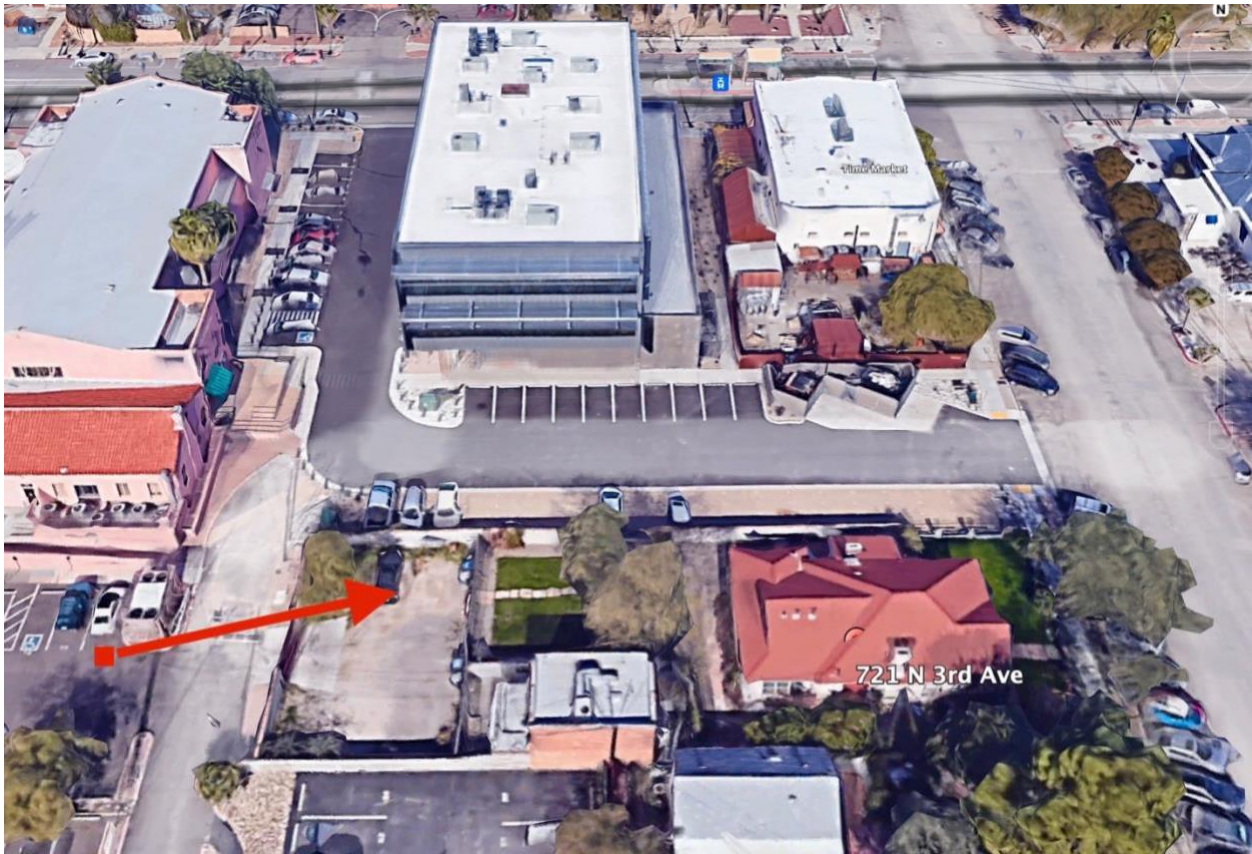

Again, proposed building site. (Google Earth)



Front of main house, showing historic marker and stucco surface on main house. We will not attempt to replicate the actual stucco look, but our smooth stucco will compliment the historic main house.

(5) Development Zone



(6) Plans submitted to Planning

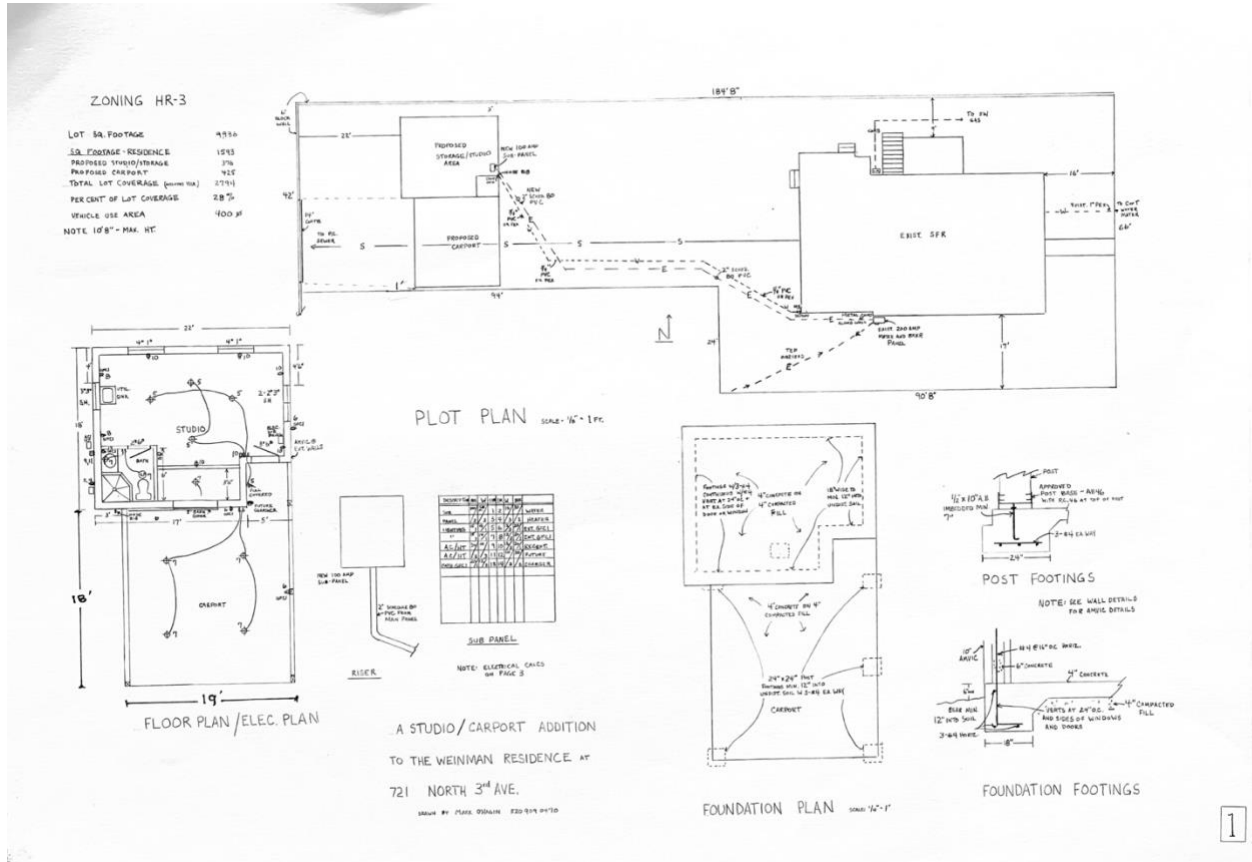

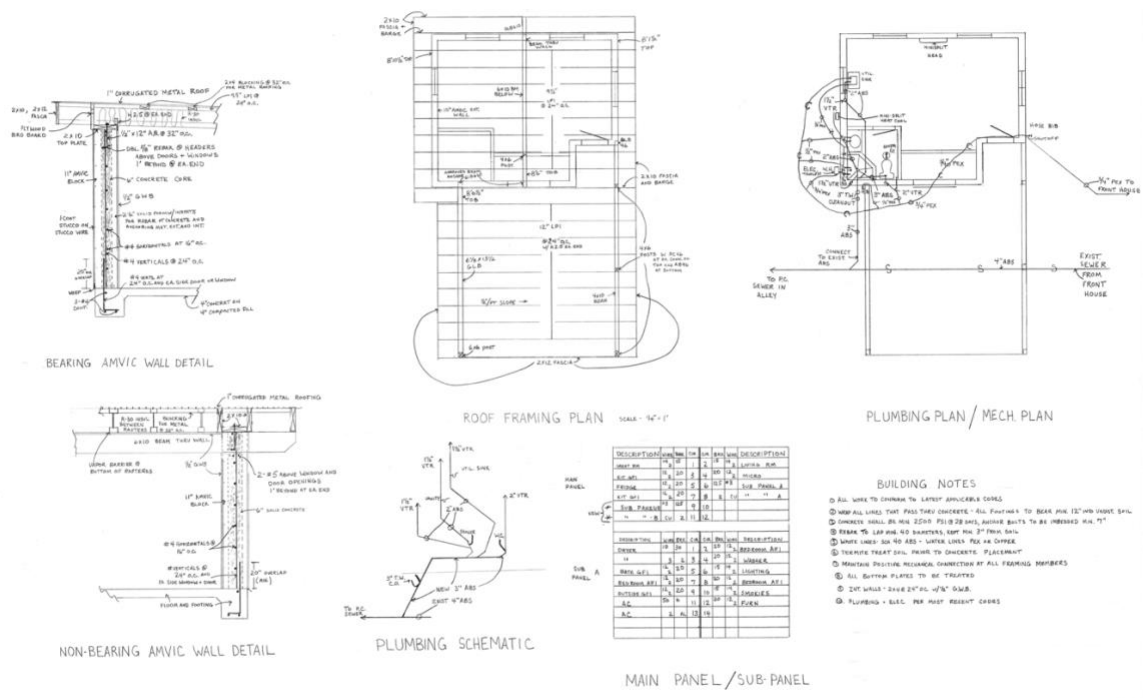

2

Additional Building notes – Especially for Historic Board approval

Windows: Note #1 Double hung wooden windows. Each window 28" wide, 4' tall. Side by side with divider between.

Note #2 Double hung wooden windows. Each window 24" wide, 3' tall. Side by side with divider between.

Note #3 Non-opening wooden framed double glass. Each window 4 ft wide, 1ft tall.

Doors: Note #4 Wooden door with glass panel. (Will have security screen door to match front house.)

Barn Door will be a solid wood, tongue and groove door.

Post Caps and Bases: All post caps and bases will be approved specifications for current building requirements, but they will be painted/covered in a way to disguise their unattractive and non-historic look.

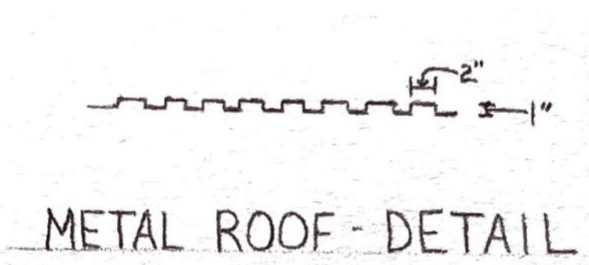

* DENOTES NEW AT STUDIO / STORAGE

1969 # x 3 W 5907
 6 APPLIANCE CIR @ 1500 9000
 * WATER HEATER 4500
 TOTAL 19,407
 1st 10,000 @ 100% 10,000
 REMAINDER @ 40% 3,762
 13,762 ÷ x 240 57 AMPS

AC #1 @ 100% 50 AMPS
 AC #2 @ 100% 30 AMPS
 CHARGER @ 100% 30 AMPS
 TOTAL 167 AMPS

ELECTRIC LOAD CALCULATIONS

(7) Elevation views of main house on property

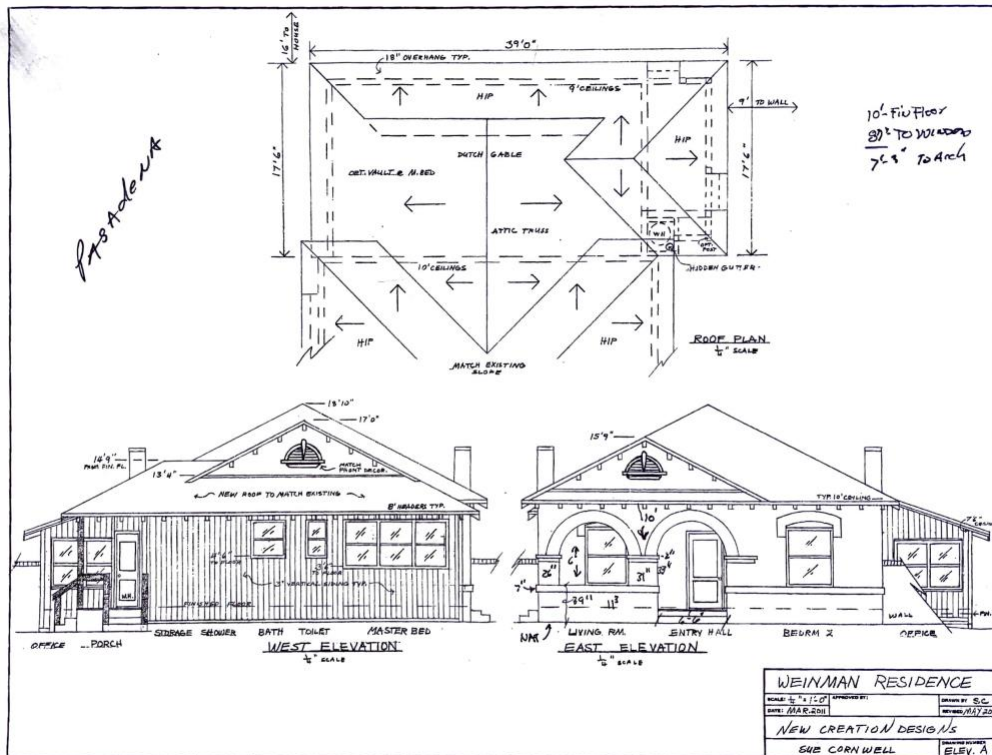

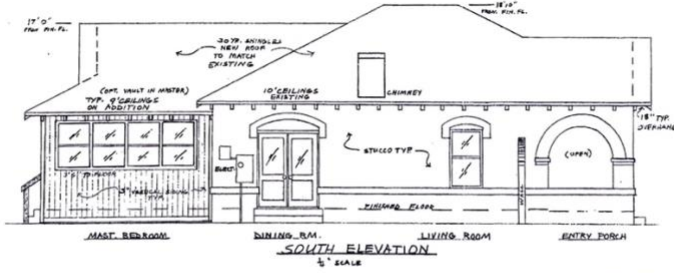
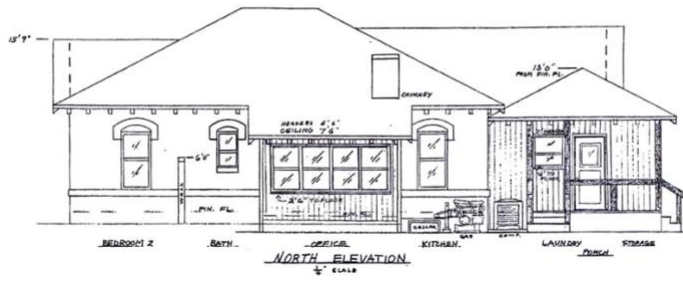

WENMAN RESIDENCE	
DATE: 5-1-07	PROJECT: SC
DESIGNER: SUE	ARCHITECT: SUE
NEW CREATION DESIGNS	
SUE CORNWELL	ELEV. B

(8) Historic property inventory of 1979

PROPERTY NAME Dusenberry House 721 N. 3rd Ave.		Block 42	Lot 8
CITY/TOWN/VICINITY Tucson, AZ		COUNTY Pima	
OWNER Lois Dusenberry			
OWNER'S ADDRESS 721 N. 3rd Ave. Tucson, AZ 85705			
FORM COMPLETED BY F. Clapper			
ADDRESS U of A College of Architecture - Tucson, AZ 85721			
PHOTO BY Barbara Tallman		DATE 7/79	
VIEW Front/side			
PRESENT USE residence		ACREAGE	
STYLE OF CULTURAL PERIOD American Victorian w/ Mission influence			
SIGNIFICANT DATES 1906			
PHYSICAL DESCRIPTION One story, stone foundation, brick load bearing walls, white stucco surface with green trim, low gable and pyramid roof, green wood shingles, front entrance porch. Minor alterations. Good condition, little change.			
STATEMENT OF SIGNIFICANCE Brick storage building in back was beginning of Tucson Van and Storage Significant because it was constructed during the territorial era.			
VERBAL BOUNDARY DESCRIPTION Tucson Lot 8 Block 42			



(9) Initial Historic Review application, March 2022



HISTORIC PRESERVATION REVIEW APPLICATION

Date Submitted: MARCH 2022 PDSD Activity Number: T21CM06430

HPZ Case Number: _____

Property Development Name: STUDIO/STORAGE CARPORT ADDITION

Property Address: 721 N. 3rd AVE

Pima County Assessor Parcel Number(s): 11703324A

HPZ: Armory Park Barrio Historico El Presidio Fort Lowell West University

Applicant Name: MARK O'HAGIN Owner Architect/Designer Other

Applicant Address: 6540 S. AV. DON FERNANDO

City/State/Zip: TUCSON AZ 85757

Phone: 520 909 0470 Email: mpohagin@OUTLOOK.COM

Property Owner Name: DSW PROPERTIES III LLC

Property Owner Phone: _____

Property Owner Email: _____

Description of Use (if Resident Artisan): _____

Signature of Owner: _____

Signature of Applicant (if not owner): Mark A. O'Hagin

PROPOSED NEW CONSTRUCTION or ALTERATION
A STORAGE, ART STUDIO WITH SINGLE CARPORT

By state law, we cannot initiate a discussion with you about your rights and options, but we are happy to answer any questions you might have.

(10) Zoning review notes regarding setbacks

Below is what we received from Zoning back in January, which is why we were delayed with our plans and felt the need to redesign with 6ft setbacks to the north and south.

ZONING REVIEW TRANSMITTAL

FROM: PDSO Zoning Review

PROJECT:
T21CM06430
721 N 3rd Ave – HR-3
Studio/Carport (3rd Review)

TRANSMITTAL: January 10, 2022

COMMENTS: the following comments are relative to an application for Historic Review (UDC 5.8.8).

This site is located in the HR-3 zone (UDC 4.7.9). A single-family residence (SFR) is a permitted use in this zone (Table 4.8-2). See Use-Specific Standards 4.9.7.B.6.

The minimum setback is the greater of six (6) feet, or two-thirds (2/3) the height of the structure's wall facing each interior property line (Table 6.3-2.A).

1. Based on a wall height of 9'-0" the required perimeter yard setback from the proposed Studio/Carport to the north property line is 6'-0" proposed setback is 3'-0".
2. Based on a wall height of 9'-0" the required perimeter yard setback from the proposed Studio/Carport to the south property line is 6'-0" proposed setback is 1'-0".

Historic review must be completed and approved prior to approval of this building permit. Historic review is a separate submittal from the building plan and is submitted at: <https://www.tucsonaz.gov/pdsd-filedrop>, using Submission Type "Historic Review". Historic application/requirements can be found at: https://www.tucsonaz.gov/files/pdsd/Preservation/HPZ_Review_Application_Package_2020.pdf.

If you have any questions about this transmittal, please contact Elisa Hamblin at ElisaHamblin@tucsonaz.gov.