

# Sharing the Road with Pedestrians

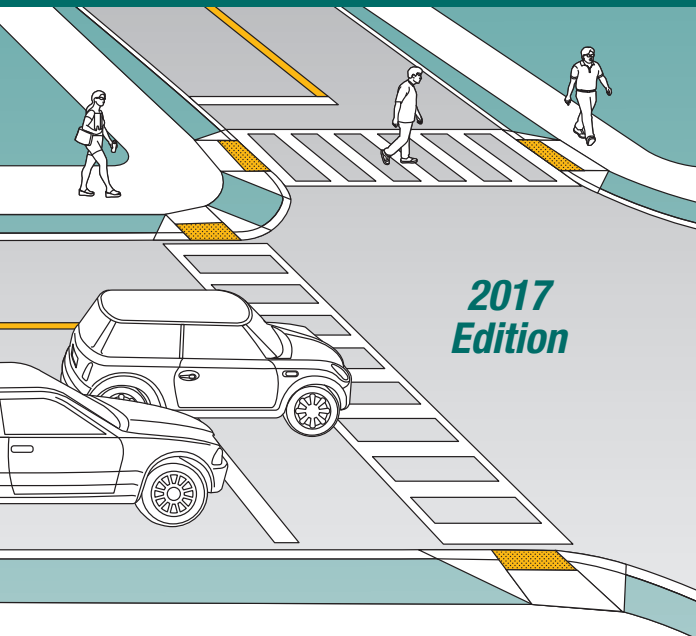

**2017  
Edition**

**ADOT**

A guide for drivers and  
pedestrians published by the  
Arizona Department of Transportation

Sponsored by



U.S. Department  
of Transportation

**Federal Highway  
Administration**

**ADOT**

---

**Multimodal Planning**



**PIMA COUNTY**

---

**BICYCLE & PEDESTRIAN PROGRAM**



# Tips for Sharing the Road Legally and Safely

This pocket guide illustrates how pedestrians and drivers can “Share the Road” legally and safely within Arizona.

Please read through these safety tips to better understand the other person’s view of the road and to learn more about walking and driving safely in our great state. The more we understand each other’s needs, the better we can respect and cooperate with each other on the streets.

This third edition of the pedestrian and driver pocket guide is brought to you by the Arizona Department of Transportation Bicycle and Pedestrian Program and the Pima County Department of Transportation.

© Copyright 2017. Produced by the Pima County Bicycle and Pedestrian Program, Matthew Zoll, Program Manager.

***Please refer to pages 33 through 40 for a listing of relevant Arizona Revised Statutes (A.R.S.) pertaining to pedestrian and driver rights and duties.***

### Drivers Must Exercise Due Care

#### 28-794. Drivers to exercise due care

Arizona law requires drivers to exercise due care to avoid colliding with a pedestrian (A.R.S. 28-794). You can do this by:

1. Clearly communicating to pedestrians by using your turn signals any time you are changing lanes or turning at an intersection.
2. Sounding the horn only when absolutely necessary to avoid a collision.
3. Being extra careful when you see children, or a confused or incapacitated person in or near the roadway.

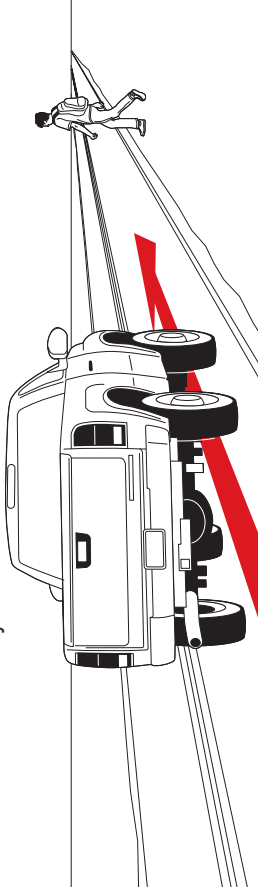

## Slow Down When Pedestrians are Present

Speeding greatly increases the chances of injury or death if a pedestrian and a vehicle are involved in a collision. A pedestrian struck at 20 m.p.h. has a 95 percent chance of survival, but if struck at 40 mph has only a 16 percent chance of survival.

### Vehicle Impact Speed and Pedestrian Injury Severity

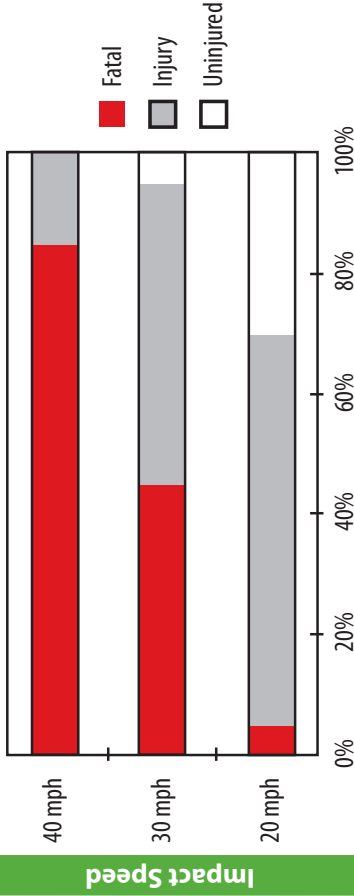

## Yield to Persons with Visual Disabilities

Tips to help drivers drive safely around pedestrians with visual disabilities:

- If a pedestrian is waiting, stop your car about five feet in front of a crosswalk or at the marked 'stop bar.' Pedestrians with visual disabilities use the sound of your engine as a guide. If you drive a particularly quiet vehicle, take extra care.
- Don't give a pedestrian with visual disabilities verbal directions because they may be confusing. The pedestrian listens to all traffic sounds before deciding to cross the street.
- Don't wait too long for a pedestrian with visual disabilities to cross the street. If the person steps back and pulls in his or her cane, it's a sign that you may proceed forward with caution.
- Look for any pedestrian or other traffic before starting your left or right turn. Don't turn right on red without looking both left and right.

- Don't stop in the middle of a crosswalk. This forces a pedestrian with visual disabilities to walk around your car and into traffic outside of the crosswalk.

- Don't honk at people with visual disabilities. They have no idea who you're honking at and may be scared by the noise.

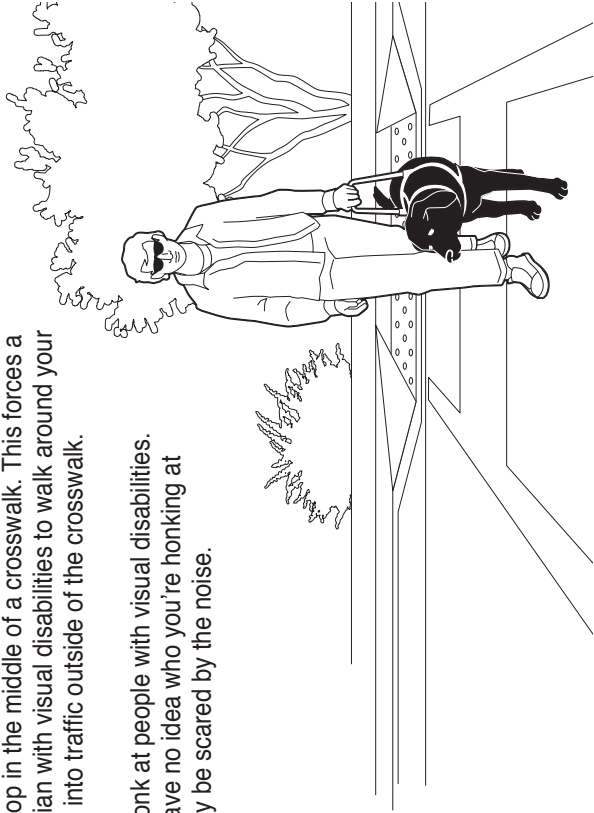

## Always Stop for School Buses with Lights Flashing

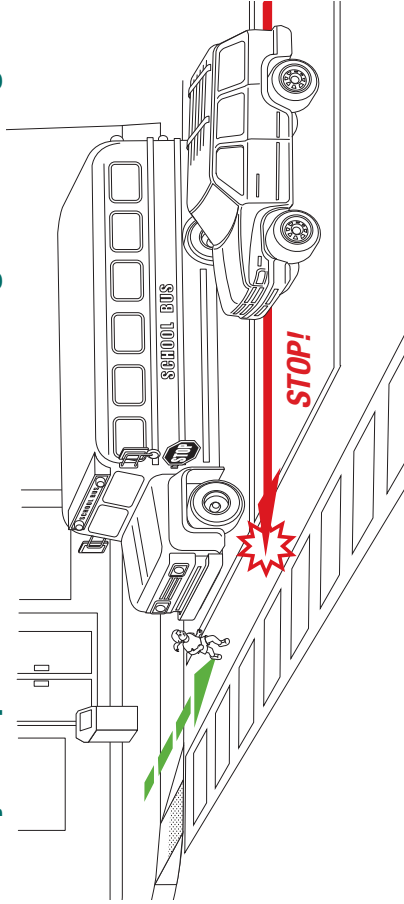

Always expect children to be around stopped school buses, even if the red lights of the bus are not flashing. It is against the law to pass a stopped school bus with its stop sign out and lights flashing (A.R.S. 28-857).

***Please slow to a safe speed and look for children.***



## Slow Down in School Zones

- School zones are located on streets where there is a designated school crossing. Crosswalks are painted yellow in school zones.
- When school zone signs are posted, the speed limit is 15 mph between portable signs.
- Drivers are not allowed to enter a school crosswalk if there is a pedestrian in any part of the crosswalk.
- Drivers cannot pass other vehicles in a school zone.
- Drivers cannot park on either side of a school crosswalk or on the crosswalk.

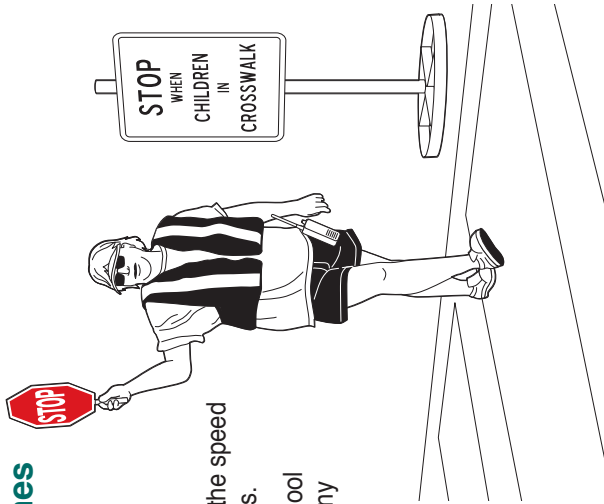

## Don't Pass Vehicles Stopped at Crosswalks

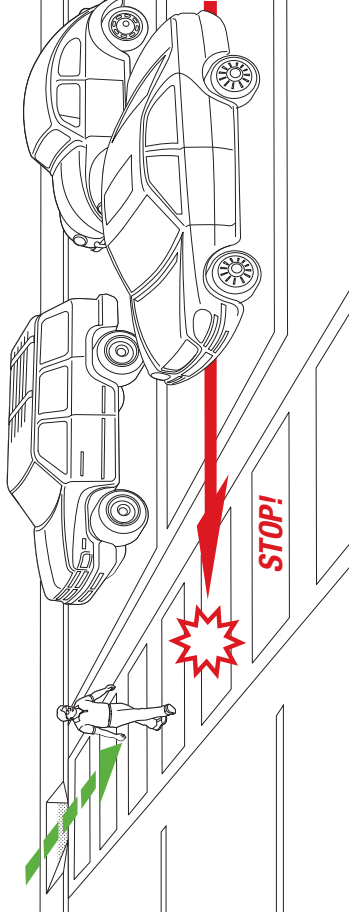

**Exercise extreme caution** when coming up alongside slowing or stopped vehicles, and be prepared to stop when pedestrians are present in marked or unmarked crosswalks.

**It is against the law to pass a vehicle stopped at a crosswalk (A.R.S. 28-792).**

## Yield to Pedestrians When Making Turns

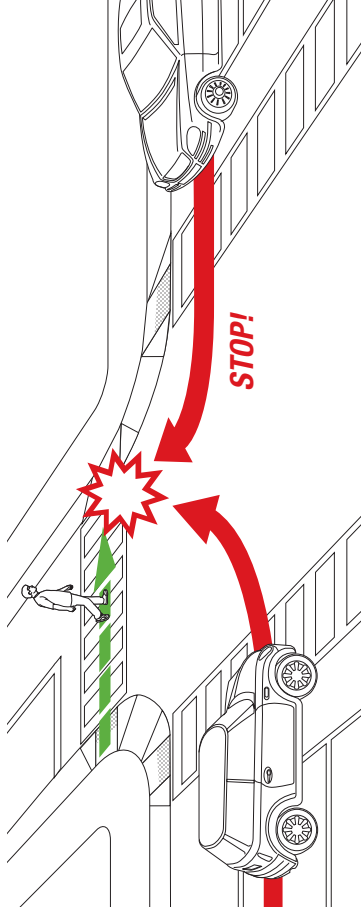

**MAKING LEFT TURNS:** Always be on the lookout for pedestrians, and scan crosswalks before turning. Be aware that your windshield support may partially block your view, so make sure the crosswalk is clear before turning.

**MAKING RIGHT TURNS:** Yield to pedestrians in the crosswalk. Where not prohibited by signs at a red light, a right turn may be made after coming to a complete stop and if motor vehicle, bicycle and pedestrian traffic are clear.

## Exit Driveways Slowly and Carefully

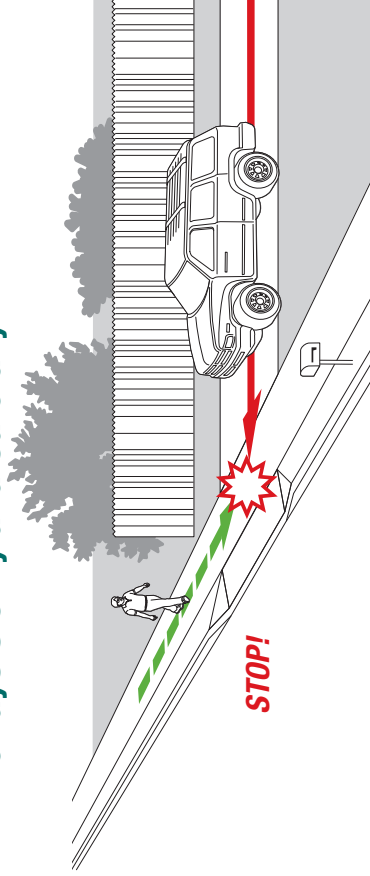

Please avoid rushing into or out of driveways. Expect pedestrians on the sidewalk or dirt shoulder, especially around schools and neighborhoods.

Also be mindful in commercial areas, where pedestrians should commonly be expected.

***Look both ways for pedestrians before turning onto the street.***

## Watch for Pedestrians Walking Along the Roadway

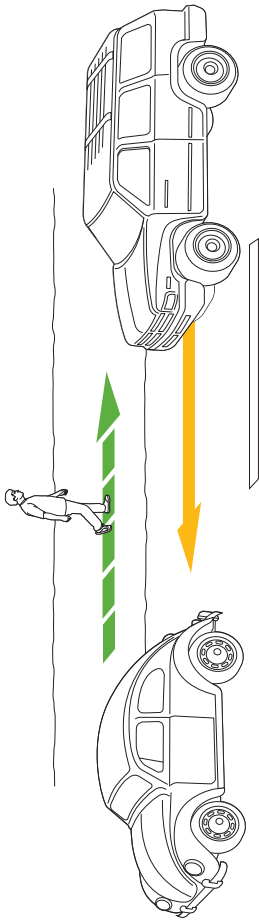

Watch for pedestrians who may be walking along a roadway without sidewalks. Remember that they have the legal right to walk or run on the edge of the roadway and that you must avoid colliding with them (A.R.S. 28-796).

## Yield to Pedestrians in Parking Lots

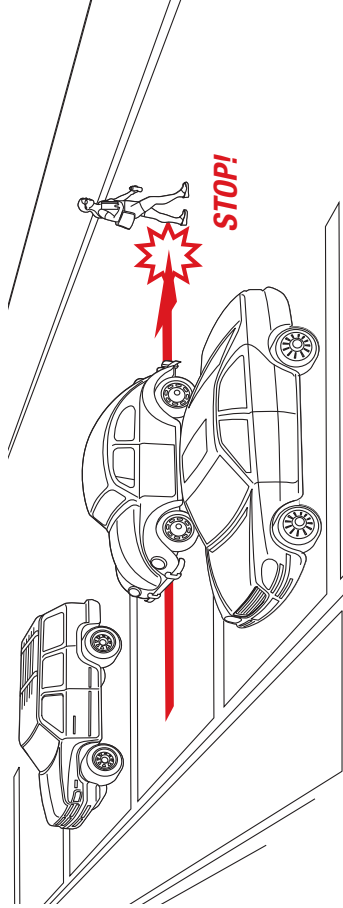

Just as you would hope that other drivers watch for you as you're walking in a parking lot, be very aware and careful around pedestrians as you're driving in a lot. Be especially watchful for children, who can be difficult to see when you're backing up your car.

Remember that a 3,000 pound vehicle can do a lot of damage even at 5 miles per hour.

## Yield to Pedestrians in Roundabouts

When approaching a roundabout, reduce your speed.

Yield to pedestrians in the crosswalk; they have the right-of-way.

When entering, yield to vehicles in the roundabout. Wait for a gap in traffic and merge into roundabout traffic.

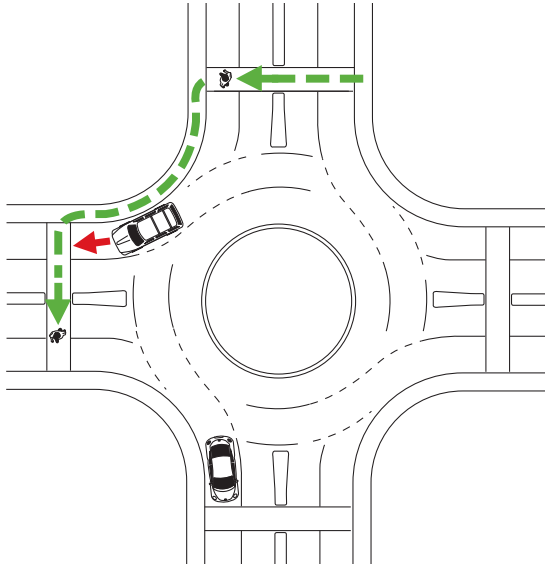

## Watch for Children Dashing Out into Traffic

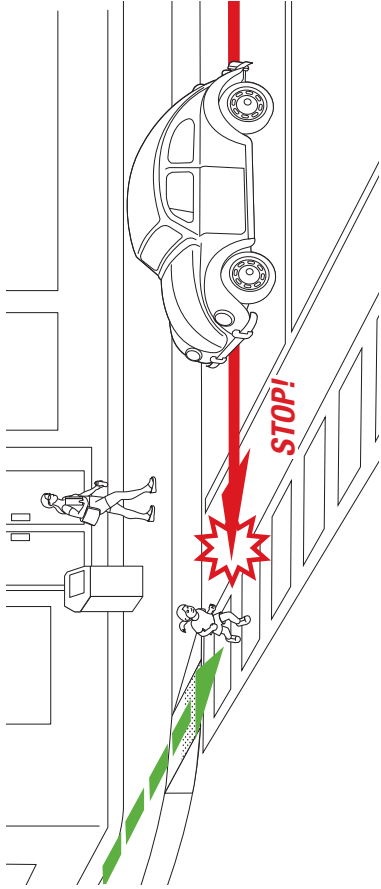

Remember that children may play in or near a street and may often enter the street unexpectedly. Children commonly dash out into the street without looking for cars.

***Please slow down and be ready to stop.***



## Obey the Signals at a Pedestrian Hybrid Beacon

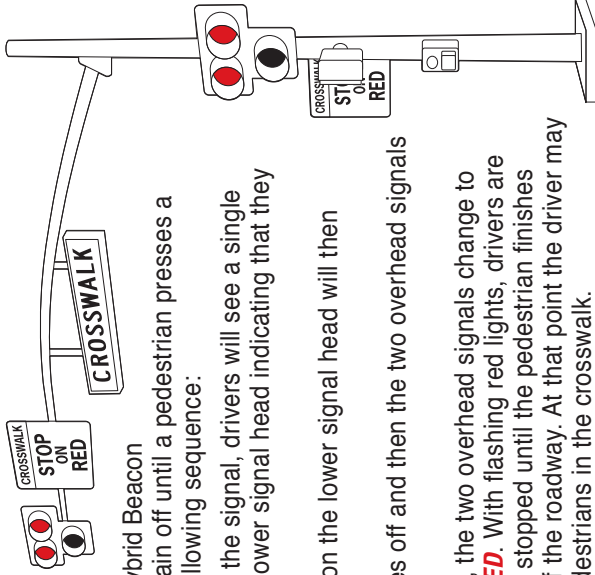

The signals at a Pedestrian Hybrid Beacon

(also known as a HAWK) remain off until a pedestrian presses a button. The HAWK has the following sequence:

1. When pedestrians activate the signal, drivers will see a single **FLASHING YELLOW** for the lower signal head indicating that they should prepare to stop.
2. The single flashing yellow on the lower signal head will then change to **SOLID YELLOW**.
3. The single solid yellow goes off and then the two overhead signals come on as a **SOLID RED**.
4. After a number of seconds, the two overhead signals change to **ALTERNATING FLASHING RED**. With flashing red lights, drivers are required to STOP and stay stopped until the pedestrian finishes crossing the driver's half of the roadway. At that point the driver may proceed if there are no pedestrians in the crosswalk.

## Yield to Pedestrians at Marked and Unmarked Crosswalks

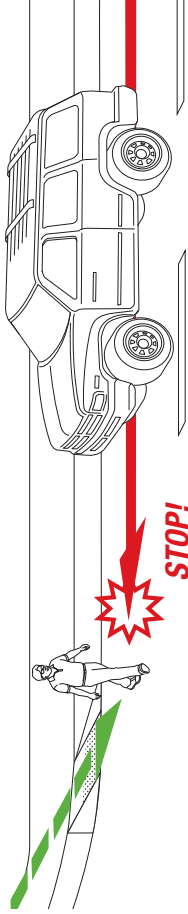

Pedestrians have the legal right to cross a roadway at and between almost all intersections. Drivers must yield to pedestrians at all marked and unmarked crosswalks.

All intersections of public streets include crosswalks, which may be marked or unmarked. There is an unmarked crosswalk where the imaginary lines of the sidewalk or edge of intersecting roadway cross the road.

***On multilane roadways, if you stop too close to a pedestrian, you may block the next driver from seeing the pedestrian as he or she is crossing the roadway.***

## Pay Attention to the Road, Not Your Phone or Tablet

Never text, surf the web or email while driving. Doing these activities while driving can take your focus off the road. It is dangerous and illegal.



*You are 23 times  
more likely to cause  
a crash if you text  
while driving!*

## Prevent Children from Dashing Out into Traffic

Children ages 5 to 9 have the **highest** risk of all pedestrians of being hit by a car, primarily due to dashing out into the street.

Teach your children to:

- Stop at the curb.
- Look left - right - left for traffic.
- Cross only when it is clear and safe.
- Walk, don't run!
- Keep looking for cars as you cross.

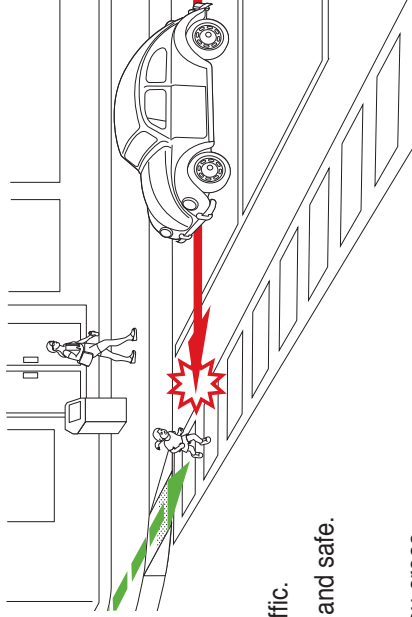

## Watch for Merging or Speeding Vehicles

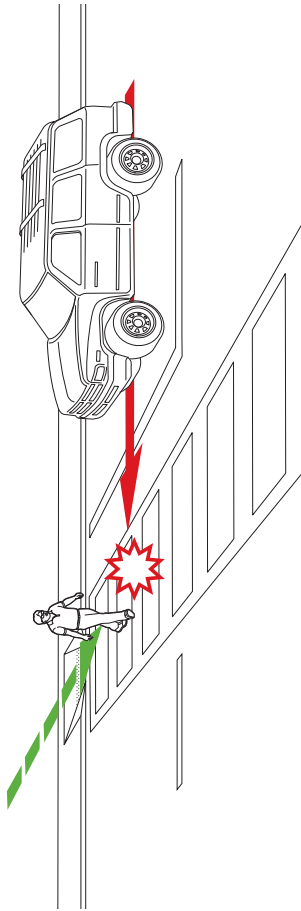

The roadway may appear clear, but a vehicle could suddenly approach when you don't expect it because the driver may have quickly turned onto it from a side street or driveway or may have merged onto it from a high-speed roadway ramp.

Try to cross at the best location where you have the best view of oncoming drivers and where drivers can best see you. Cross with your children at intersections whenever possible.

## Be Safe Around School Buses

*Practice these rules with your child for staying safe around a school bus:*

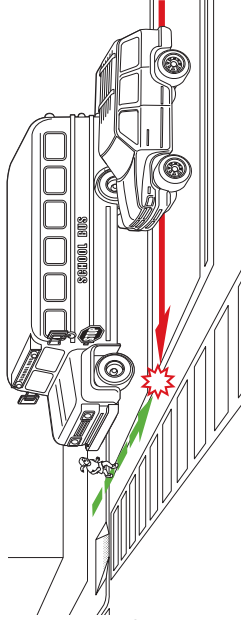

- Stand at least three steps away from the edge of the road.
- Wait until the bus stops, the door opens, and the driver says it's okay to get on.
- To cross the street in front of the bus, walk five steps ahead of the bus before you cross. Be sure you and the bus driver can see each other.
- Never walk behind the bus. The bus driver can't see you and may suddenly start to back up.
- If you drop something near or under the bus, tell the driver. Never try to pick it up. The driver may not see you and begin to drive.

## Always Assume that Drivers May Not Stop

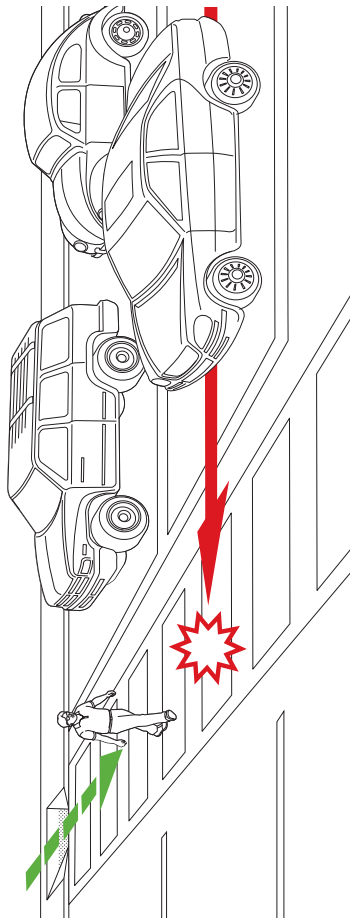

A marked crosswalk does not assure your safety. Make sure that all vehicles are stopped before crossing each lane.

This is extremely important to teach your children. Teach them that **each lane** must be stopped before crossing.

## Watch for Turning Vehicles

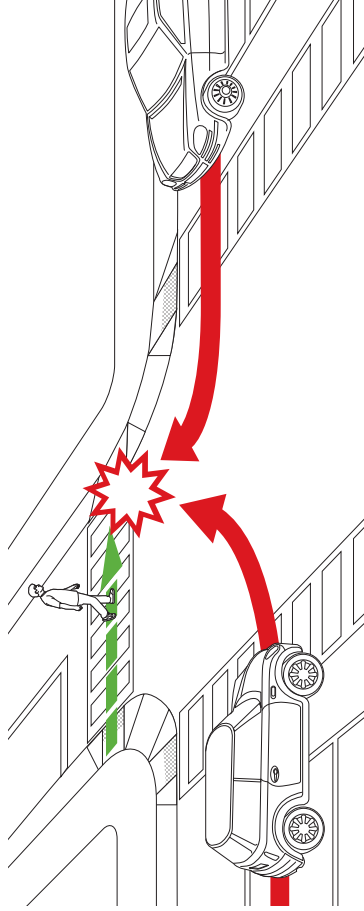

Many times, a turning driver is looking at oncoming traffic and may not see you until he or she is actually making the turn. Scan over your shoulder and behind you as you are crossing the street. You may need to wave your arm overhead to catch the attention of the turning driver.

Children are often unaware of this condition and must be trained carefully to watch for turning drivers.



## Watch for Cars When Crossing Driveways

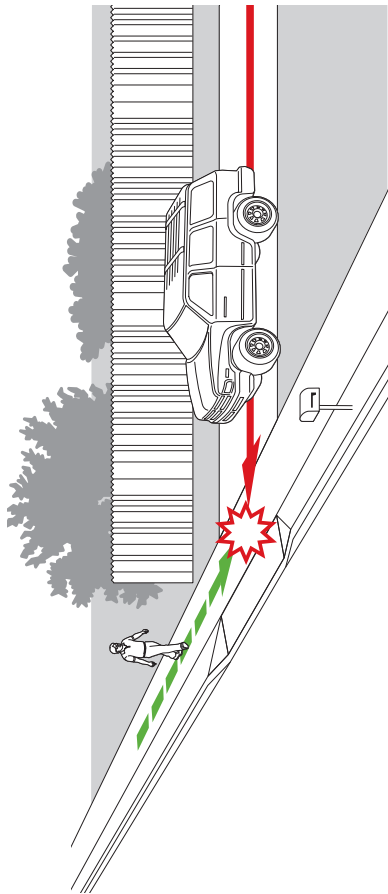

Drivers exiting a driveway sometimes may not really “see” pedestrians, especially children. Expect that a driver may not see you.

This is a major concern in commercial as well as residential areas. Teach your children to be especially careful when approaching or crossing driveways.

## Be Visible to Drivers

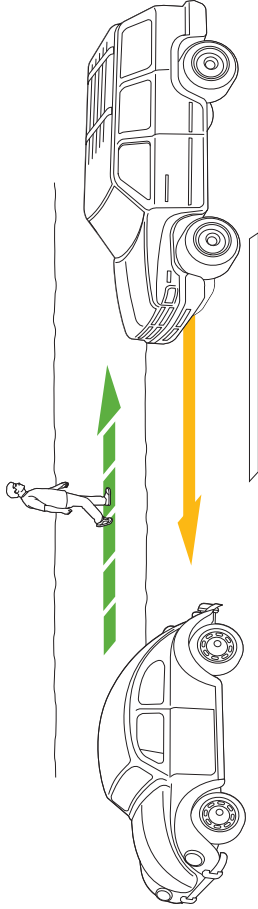

On roadways without sidewalks, walk facing traffic whenever possible and at night wear bright-colored reflective clothing and carry lights.

Make sure you and your children are as visible as possible.

**Remember:** Drivers do their best to avoid you if they can see you!

## Parking Lots Can Be Hazardous

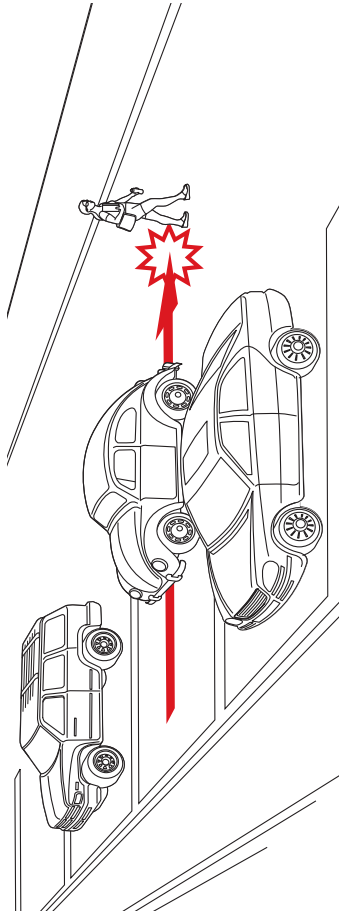

Be aware of traffic at all times, and mind your children carefully. Try to exit parking lots as soon as possible, or walk along the edges.

Keep control of your children in parking lots at all times, as they can be very difficult for drivers to see. Don't allow them to run or play in parking lots.

## Runners Should Use the Same Guidelines as Walkers

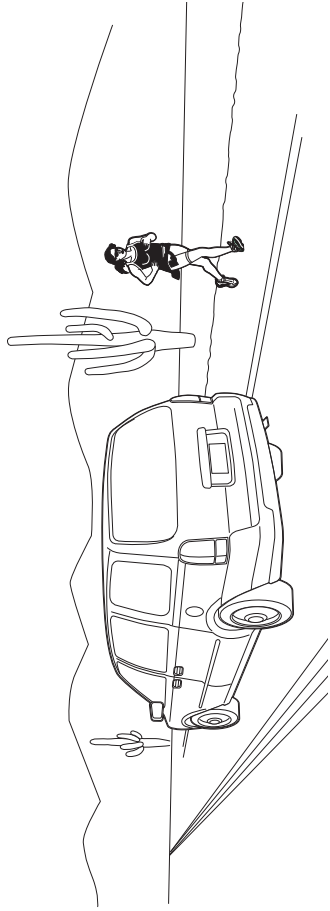

When possible, run in the opposite direction of traffic where there are no sidewalks. Don't dart out when crossing the roadway. Be extra alert because you could be moving at a faster pace than drivers expect.

**Stay alert!** Keep your attention on the road and traffic in front of you. Don't assume that drivers see you. Be especially cautious of right-turning drivers coming from side streets or driveways.

## How to Use Pedestrian Signals

Follow these signals and stay safe crossing the street.

### The Countdown Pedestrian Signal



*Start crossing,  
watch for vehicles.*



*Don't start. Time remaining  
to finish crossing.*



*Steady.  
Don't cross.*

### The Old-Style Pedestrian Signal



*Start crossing,  
watch for vehicles.*



*Don't start. Finish  
crossing if started.*



*Steady.  
Don't cross.*

**Please note:** If the countdown signal has started, or the orange hand has started flashing, you cannot leave the curb to cross the road.

## Tips for Walking in Rural Areas

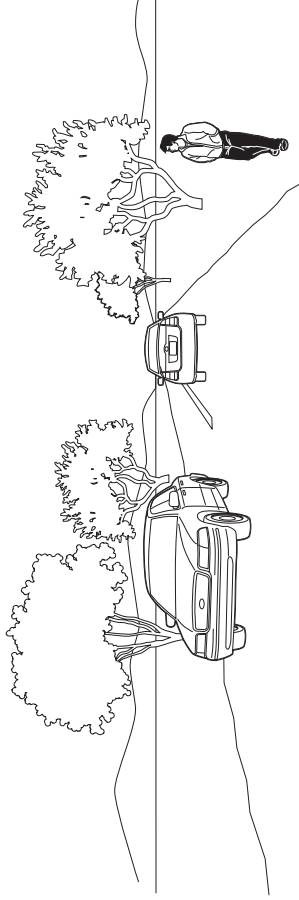

If there are no sidewalks, walk facing oncoming traffic whenever practical and stay as far off the roadway as possible.

Remember that at dusk or dawn when the sun is low, drivers may not see you.

Wear bright colored and reflective clothing that contrasts with the surroundings. Carry a flashlight in low light conditions but don't aim it directly at drivers.

## Use Crosswalks to Get Across Roundabouts

Use pedestrian crossings to cross roadways in a roundabout.

Look left before crossing to median island; look right before crossing to opposite sidewalk.

At roundabouts with two entering and exiting lanes make sure each lane of traffic is stopped before crossing.

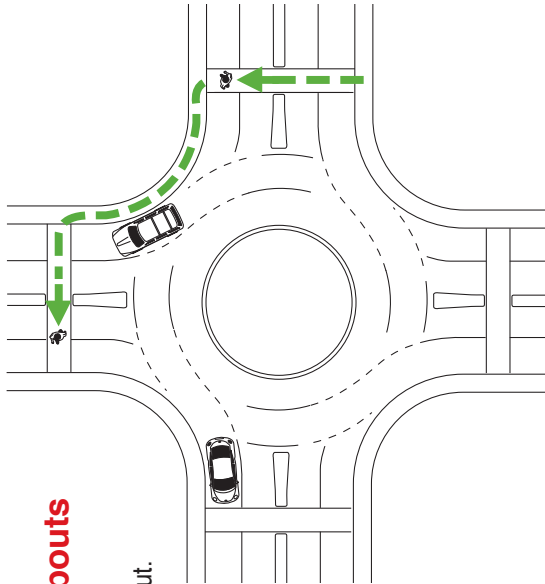

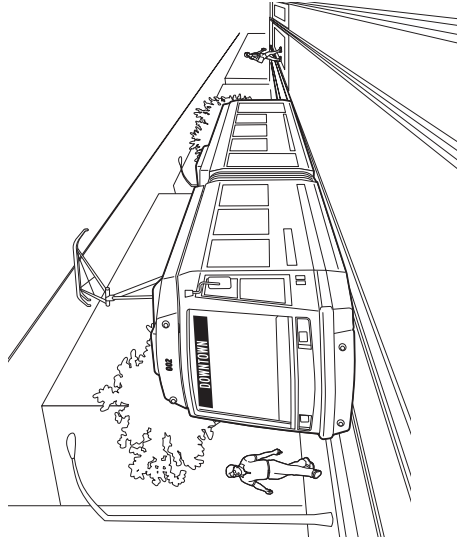

- Don't walk or stand on the tracks.
- Use the pedestrian walkways and crosswalks. Pay attention to and obey the crosswalk countdown signals.
- Light rail and streetcars are quiet. Listen for warning bells and look for headlights.
- Adults should hold children's hands near tracks and on platforms.
- Keep volume low on headphones, so that you are aware of your surroundings.
- Always stand behind the textured strips on platforms.



## Give Large Trucks Plenty of Room

- Stay a safe distance from trucks and buses when walking or driving.
- Large vehicles have several blind spots where visibility is limited.
- The rear wheels follow a shorter path than the front wheels and can come into your lane or even up onto the curb.

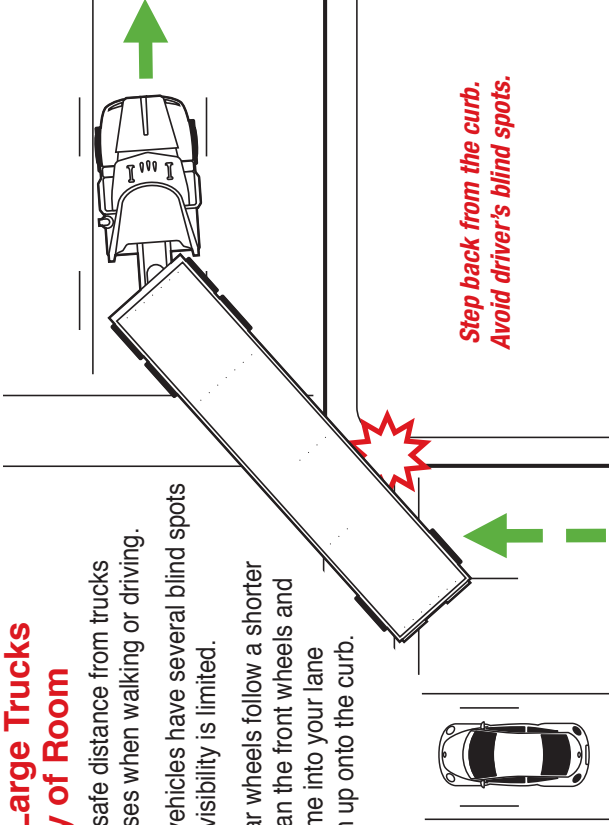

## Pay Attention and Be Aware of Your Surroundings

Wearing headphones and using cell phones cause distraction and reduce your ability to hear traffic, which could cost you your life.

Your ears are your first line of defense when walking or running near traffic.

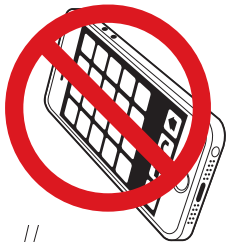
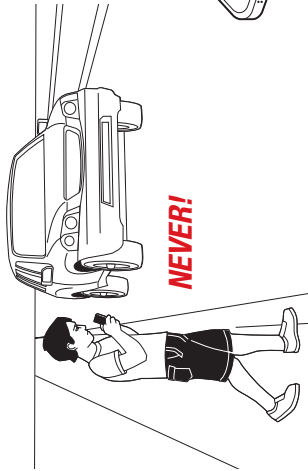

## Relevant Pedestrian Statutes

Arizona Revised Statutes as of January 2017

### 28-101. Definitions

“**Pedestrian**” means any person afoot. A person who uses an electric personal assistive mobility device or a manual or motorized wheelchair is considered a pedestrian unless the manual wheelchair qualifies as a bicycle. For the purposes of this paragraph, “motorized wheelchair” means a self-propelled wheelchair that is used by a person for mobility.

“**Electric personal assistive mobility device**” means a self-balancing two non-tandem wheeled device with an electric propulsion system that limits the maximum speed of the device to fifteen miles per hour or less and that is designed to transport only one person.

### 28-601. Definitions

“**Crosswalk**” means:

- (a) That part of a roadway at an intersection included within the prolongations or connections of the lateral lines of the sidewalks on opposite sides of the highway measured from the curbs or, in absence of curbs, from the edges of the traversable roadway.

(b) Any portion of a roadway at an intersection or elsewhere that is distinctly indicated for pedestrian crossing by lines or other markings on the surface.

**“Intersection”** means the area embraced within the prolongation or connection of the lateral curb lines, or if none, the lateral boundary lines of the roadways of two highways that join one another at, or approximately at, right angles, or the area within which vehicles traveling on different highways joining at any other angle may come in conflict. If a highway includes two roadways thirty or more feet apart, each crossing of each roadway of the divided highway by an intersecting highway is a separate intersection. If the intersecting highway also includes two roadways thirty or more feet apart, each crossing of two roadways of the highways is a separate intersection.

**“Motorized wheelchair”** means any self-propelled wheelchair that is used by a person for mobility.

**“Roadway”** means that portion of a highway that is improved, designed or ordinarily used for vehicular travel, exclusive of the berm or shoulder. If a highway includes two or more separate roadways, roadway refers to any such roadway separately but not to all such roadways collectively.

“**Sidewalk**” means that portion of a street that is between the curb lines or the lateral lines of a roadway and the adjacent property lines and that is intended for the use of pedestrians.

“**Traffic**” means pedestrians, ridden or herded animals, vehicles and other conveyances either singly or together while using a highway for purposes of travel.

### **28-646. Pedestrian control signals; loitering prohibited**

- (a) If special pedestrian control signals exhibiting the words “walk” or “don’t walk” are in place, the signals shall indicate as follows:
1. **Walk.** Pedestrians facing the signal may proceed across the roadway in the direction of the signal and shall be given the right-of-way by the drivers of vehicles.
  2. **Don’t walk.** A pedestrian shall not start to cross the roadway in the direction of the signal, but a pedestrian who has partially completed crossing on the walk signal shall proceed to a sidewalk or safety island while the don’t walk signal is showing.
- (b) A pedestrian shall not loiter or unduly delay crossing the roadway after traffic has stopped to give the right-of-way.

**28-791. Pedestrians subject to traffic rules**

- (a) Pedestrians are subject to traffic control signals at intersections as provided in section 28-645 unless required by local ordinance to comply strictly with the signals. At all places other than intersections, pedestrians are accorded the privileges and are subject to the restrictions stated in this article.
- (b) A local authority may require by ordinance that pedestrians strictly comply with the directions of an official traffic control signal and may prohibit by ordinance pedestrians from crossing a roadway in a business district or crossing a designated highway except in a crosswalk.

**28-792. Right-of-way at crosswalk**

- (a) Except as provided in section 28-793, subsection B, if traffic control signals are not in place or are not in operation, the driver of a vehicle shall yield the right-of-way, slowing down or stopping if need be in order to yield, to a pedestrian crossing the roadway within a crosswalk when the pedestrian is on the half of the roadway on which the vehicle is traveling or when the pedestrian is approaching so closely from the opposite half of the roadway as to be in danger. A pedestrian shall not suddenly leave any curb or other place of safety and walk or run into the path of

a vehicle that is so close that it is impossible for the driver to yield.

- (b) If a vehicle is stopped at a marked crosswalk or at an unmarked crosswalk at an intersection to permit a pedestrian to cross the roadway, the driver of another vehicle approaching from the rear shall not overtake and pass the stopped vehicle.

### **28-793. Crossing at other than crosswalk**

- (a) A pedestrian crossing a roadway at any point other than within a marked crosswalk or within an unmarked crosswalk at an intersection shall yield the right-of-way to all vehicles on the roadway.
- (b) A pedestrian crossing a roadway at a point where a pedestrian tunnel or overhead pedestrian crossing has been provided shall yield the right-of-way to all vehicles on the roadway.
- (c) Between adjacent intersections at which traffic control signals are in operation, pedestrians shall not cross at any place except in a marked crosswalk.

### **28-794. Drivers to exercise due care**

Notwithstanding the provisions of this chapter every driver of a vehicle shall:

1. Exercise due care to avoid colliding with any pedestrian on any roadway.
2. Give warning by sounding the horn when necessary.
3. Exercise proper precaution on observing a child or a confused or incapacitated person on a roadway.

### **28-795. Pedestrians to use right half of crosswalk**

Pedestrians shall move expeditiously, when practicable, on the right half of crosswalks.

### **28-796. Pedestrian on roadways**

- (a) If sidewalks are provided, a pedestrian shall not walk along and on an adjacent roadway.
- (b) If sidewalks are not provided, a pedestrian walking along and on a highway shall walk when practicable only on the left side of the roadway or its shoulder facing traffic that may approach from the opposite direction.
- (c) A person shall not stand in a roadway for the purpose of soliciting a ride from the driver of a vehicle.



### **28-856. Emerging from alley, driveway or building**

The driver of a vehicle emerging from an alley, driveway or building within a business or residence district shall:

1. Stop the vehicle immediately before driving onto a sidewalk or onto the sidewalk area extending across any alleyway or private driveway.
2. Yield the right-of-way to any pedestrian as necessary to avoid collision.
3. On entering the roadway, yield the right-of-way to all closely approaching vehicles on the roadway.

### **28-857. School bus signs; overtaking and passing school bus (excerpts)**

A. On meeting or overtaking from either direction a school bus that has stopped on the highway, the driver of a vehicle on a highway shall:

1. Stop the vehicle before reaching the school bus, if the school bus is displaying the signal as provided in subsection D of this section and if alternately flashing lights are in use.
2. Not proceed until the school bus resumes motion or the signal and alternately flashing lights are no longer displayed.

## **28-904. Driving on sidewalk**

- (a) A person shall not drive a vehicle on a sidewalk area except on a permanent or duly authorized temporary driveway.
- (b) This section does not apply to a motorized wheelchair, electric personal assistive mobility device, authorized emergency vehicle, security vehicle owned by this state or small service vehicle owned by this state or a political subdivision of this state.

## **28-908. Persons in wheelchairs or on electric personal assistive mobility devices**

A person operating a wheelchair or motorized wheelchair or an electric personal assistive mobility device has all of the rights and duties that are contained in this chapter and chapters 4 and 5 of this title and that are applicable to pedestrians except provisions that by their nature can have no application.

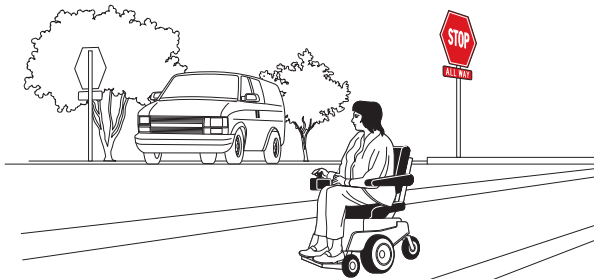





**Arizona Department of Transportation  
Bicycle and Pedestrian Program**

Mail Drop 310B  
206 S. 17<sup>th</sup> Ave., Phoenix, AZ 85007  
(602) 712-8141

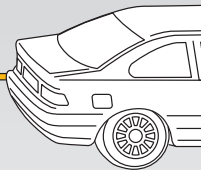
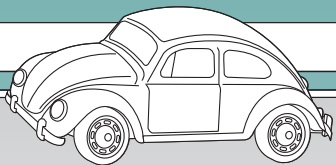

[www.azbikeped.org](http://www.azbikeped.org)

© 2017 Arizona Department of Transportation.

Created by the Pima County Bicycle and Pedestrian Program,  
Matthew Zoll, Program Manager.

Design and illustration by Dave Burnham,  
Pima County Communications Office